



RAYTECH USA, Inc.

118 S. 2nd Street, Perkasie, PA 18944 USA

Tel. 267 404 2676 Fax. 267 404 2685

Instruction Manual



**Three Phase Automatic
Transformer Turns Ratiometer Test System
Model: TR-Mark III 250V**



TABLE OF CONTENTS

1	Safety Precautions.....	3
2	Unpacking.....	4
3	Introduction.....	5
3.1	History.....	5
3.2	General.....	5
3.3	Advantages & Features.....	6
3.4	System Details.....	7
3.4.1	System Check:.....	7
3.4.2	Transformer Turns Ratio Testing:.....	7
3.4.3	Transformer Turns Ratio Meter uses:.....	8
3.4.4	Limitations of Turns Ratio Testing:.....	8
4	Quick Start Guide.....	9
4.1	Instrument operation.....	9
4.2	Connection to Test Object.....	10
4.2.1	Hooking up a transformer.....	10
4.2.2	Comparison of International Standards.....	11
5	Operation Elements.....	12
5.1	Front Panel Overview:.....	12
5.2	Control Elements and Connections.....	12
5.2.1	Fuse, Mains Input and Switch.....	12
5.2.2	Ground Terminal.....	12
5.2.3	Emergency Off.....	12
5.2.4	High Voltage Side.....	12
5.2.5	Low Voltage Side.....	12
5.2.6	3 Phase Extension (T-REX).....	13
5.2.7	External.....	13
5.2.8	Interface.....	13
5.2.9	Safety Indicator.....	13
5.2.10	Display and Touch Panel.....	13
5.2.11	Thermal Printer.....	13
6	Operation Elements Field Case.....	14
6.1	Rack: Front Panel Overview.....	14
6.2	Rack: Rear Panel Overview.....	14
7	Transformer, Measurement and Data Structure.....	15
7.1	Introduction.....	15
7.2	How it works.....	15
8	Operating Menu.....	17
8.1	Main Screen.....	18
8.1.1	Operating on a simple screen, no Transformer Data entered.....	18
8.1.2	Further Options of the Main Screen.....	20
8.1.3	Operating on an advanced Screen, Transformer Data entered.....	22
8.1.4	Taps.....	24
8.1.5	More Taps.....	26
8.1.6	Tertiary Winding System.....	27
8.2	New.....	29
8.2.1	New Transformer.....	30
8.2.2	Load from Archive.....	33
8.2.3	Copy Actual Transformer.....	34
8.2.4	New Measurement.....	35
8.2.5	Working with Templates.....	35
8.3	Info.....	36
8.3.1	Enter Tap Changer Data by Wizard.....	38
8.3.2	Enter Tap Changer Data manually.....	38
8.4	Archive.....	39
8.5	Setup.....	40
8.5.1	General.....	41
8.5.1	Operators.....	42
8.5.2	Standards.....	42
8.5.3	Printer.....	42
8.5.4	Color.....	42
9	Technical Specification.....	43
10	Interfaces.....	45
10.1	Hardware.....	45
10.2	Raytech Toolbox.....	46
10.3	TR-Mark III 250V Communication Port.....	47
10.3.1	Hardware Protocol.....	47
10.3.2	Software Protocol.....	47
10.4	TR-Mark III 250V Remote Commands.....	47



1 Safety Precautions

The following safety precautions must be observed during all phases of operation, service and repair of this instrument. By purchasing this equipment the purchaser assumes all liability for the operation and use of this equipment. The intended use of the instrument, its design and manufacture, is to be conducted within the precautions or other specific warnings located within this manual. Failure to comply with these precautions and other specific warnings violates safety standards of design, manufacture, and intended use. Raytech and its' affiliates assume no liability for the operation and use of this equipment.

SAFE OPERATION:

Only qualified knowledgeable persons should be permitted or attempt to operate this test equipment. All test personnel should fully familiarize themselves with the correct application and operation of this and all test equipment prior to operation. Persons directly and indirectly engaged in the operation of this test equipment should keep clear of all high voltage apparatus while conducting tests and measurements.

BEFORE APPLYING POWER:

Do not vary the input power source voltage level (IE...Connected to a variable AC power source). The TR-MARK III 250V auto-senses the input power from the mains plus from 100 to 250 vac 50/60Hz. Varying the input voltage will cause the test voltage to vary and result in a higher or lower test voltage than indicated.

GROUND THE INSTRUMENT:

To minimize shock hazard, the instruments Ground Terminal must be connected to a properly grounded receptacle. In many cases, the quality of the safety ground provided by the power cord does not fulfil safety needs. Also the power cord supplied with the equipment must be connected an electrical receptacle with an electrical ground (safety earth ground). Non grounded instruments are dangerous and may cause instrument damage.

KEEP AWAY FROM LIVE CIRCUITS:

Operating personnel must not remove instrument covers. Component replacement and internal adjustments must be made by qualified service personnel. Do not replace components with power cable connected. To avoid injuries, always disconnect power, discharge circuits, and remove external voltage sources before touching components.



WARNING!

⇒ Never connect TR-Mark III 250V to a transformer, which is connected to power lines.

DO NOT OPERATE IN AN EXPLOSIVE ATMOSPHERE:

Do not operate the instrument in the presence of flammable gases or fumes.

DO NOT SUBSTITUTE PARTS OR MODIFY INSTRUMENT:

Because of the danger of introducing additional hazards, do not install substitute parts or perform any unauthorized modification to the instrument. Return the instrument to a Raytech service department for service to ensure proper operation and that safety features are maintained.

Instruments, which appear damaged or defective, should be made inoperative and secured against unintended operation until they can be repaired by qualified service personnel.



2 Unpacking

Unpack your new TR-Mark III 250V and check to see that you have the following standard items:



Instrument



Cable Bag



H and X Lead set



2 Extension Cables



Power Cord



Safety Ground



USB Memory Stick



5 Paper Refills



Instruction Manual

If any of the above items are missing or damaged contact your local representative or Raytech USA immediately.



NOTE

- ⇒ The TR-Mark III 250V field case is a waterproof design. When the case is unlocked, a small hole automatically opens, to compensate atmospheric pressure changes.
- ⇒ The field case is not a shipping container.



3 Introduction

3.1 History

Raytech first developed the Transformer Turns Ratio **Spy (TR-Spy)** for high degree of accuracy for the research and development of transformers. This technology was then packaged into a portable test system for use by transformer manufacturers, rebuild shops, and electrical maintenance crews. This first system had become the most widely respected precision instrument for the ease of use, design, and operation. This first system was developed with the assistance of transformer manufacturer's and utility test crews.

The second generation **TR-Spy Mark II** took this initial development and added many new features to the system including a large memory base, external control for tap changer testing and automatic voltage level detection test. The TR-Spy Mark II was a completely new approach in technology and has become the standard for ratio testing.

Now, the third generation TR-MARK III 250V offers new features and increased accuracy to make it a perfect system. A Color LCD with back lighting and touch screen increases handling and user comfort. Two USB interfaces make it easy to store measurements on external storage devices and transfer easily to a personal computer. And Test Reports; just print them on the internal printer or from your computer.

3.2 General

Ease of use: This system is designed to be easily used and understood. Once the buttons and few menus are learned, the system is very simple to understand and operate. This intelligent system analyzes the configuration of a transformer and performs all required measurements automatically for Voltage Ratio, Turns Ratio, Current, and Phase Displacement. The system can operate a full 3 phase testing sequence with a single push button operation. Connect the leads; select the transformer configuration & press GO to test.

Impressive Accuracy: The TR-Mark III 250V is a high precision, fully automatic, microprocessor based, Single and Three Phase Transformer Turns Ratio Test system. This system is designed for highly accurate readings on-site with laboratory precision. It is the most accurate system available.

Unique Measuring Technique: This newly designed technique of measurement incorporates a high precision dual-vector voltage meter for ratio readings and a rectification resolution circuit for phase displacement (vector group). The phase displacement (vector group) can be automatically detected and displayed without operator intervention.

Operation: The TR-Mark III 250V applies a small voltage on the HIGH winding side of the transformer and measures back through the LOW side of the transformer. Analysis is made and the system determines whether a test can be conducted. Then the system applies the test voltage on the HIGH winding side of the transformer and measures the voltage back through the LOW side of the transformer. This technique has been determined to be the safest possible method of ratio testing. The results are reported on the easy to read touch-screen display.

Advanced Protection: Upon powering on the system initializes itself with a self-calibrating, circuit checking sequence. If any problems are detected during this initialization period, or during operation, the operator is immediately notified. The system constantly monitors the condition of the transformer under test. The TR-Mark III 250V can even recognize shorted leads and will terminate the test without any damage to the test equipment. This works especially well when test leads accidentally fall free from the transformer while under full voltage measurement. Accidental interchanging of the test leads on the High and Low voltage side is also detected and the measurement is safely halted.

Simple Maintenance: There is No maintenance required. There is No calibration procedure (No potentiometers to turn). This is due to the utilization of high precision components in the design.



3.3 Advantages & Features

- Color LCD with backlighting and touch screen
- Automatic measurements of Voltage, Turns Ratio, Current, and Phase displacement
- Easy one time hook up to the transformer
- Automatic test voltage range
- Displays deviation from a nominal ratio
- Graphical tap changer display
- Touch changer interface
- Load on test object <math><0.05\text{ VA}</math>
- Measures Power transformers, PTs and CTs
- Displays % error vs. name plate value
- Automatic phase vector detection
- Enhanced heavy-duty protection circuitry
- Extremely rugged
- Data exchange via USB Key
- Internal Printer
- Auto-detect phase displacement
- 5 Year standard warranty
- External test initiation for Tap changers
- Emergency shut-off switch
- Light, waterproof case
- Auto-detect short circuit or reverse connected transformers
- USB & RS232 ports
- Operates on a wide input voltage: from 100 to 250 Vac
- Ratio Accuracies of 0.06% Reading
- Stores more than 10,000 test results
- Extension cables can be cascaded to any length
- International Standards selectable



3.4 System Details

3.4.1 System Check:

The instrument is Line operated. The system is designed to be used with voltage power sources (mains power) between 100-250 Vac 50/60Hz. The system performs a self-check each time that it is powered on. The User should always visually inspect all connectors, cables and devices to be measured to avoid any safety issues.

3.4.2 Transformer Turns Ratio Testing:

A Transformer Turns Ratio Meter does exactly as its name implies; it is used primarily for checking the ratio of Turns of wires of the primary side and the secondary side of a transformer. The Turns Ratio test set does not tell exactly how many turns of wire are in the primary and secondary coils. But rather, it measures and displays the **Ratio** of (or comparison of) the number turns in the primary coil to the number of turns in the secondary coil.

This is an extremely useful device for checking for shorted turns and incorrect settings of tap changers. The TR-Mark III 250V has an additional feature of allowing the operator to measure the actual phase angle and vector relationship of the windings.

It is important to understand that the Nameplate Ratio on most transformers is the Voltage ratio (Voltage in: Voltage out) and this Ratio is determined, basically, by the number of turns of wire on the Primary (High side), the number of turns of wire on the Secondary (Low Side).

On a single phase Transformer the Turns Ratio is the same as the Voltage Ratio.

A Single Phase transformer:

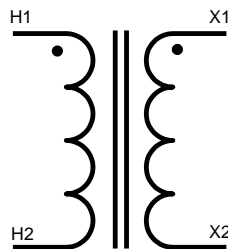

For example: The High Side Winding may contain 940 Turns: Low Side Winding 440 Turns.

$$\text{Therefore: } \textit{TurnsRatio} = \frac{\textit{PrimaryTurns}}{\textit{SecondaryTurns}} = \frac{940}{440} = 2.136$$

With three (3) Phase Transformers of different configurations, the Turns Ratio & Voltage Ratio can, and usually is different.



NOTE

- ⇒ The TR-Mark III 250V makes all the calculations and interconnections required when the correct configurations of single (1) phase and three (3) phase transformers are selected. In most cases, no other external connections, other than the test leads provided, are required. Refer to: Section 1: Safety Precautions for safety grounding.
- ⇒ Hooking up to a transformer:
The TR-Mark III 250V protects against a wrong hook-up to a transformer or testing a severely defective transformer. Every effort has been made to alert the operator when something is wrong.
- ⇒ Negative (reverse polarity) hook up is also automatically detected.



3.4.3 Transformer Turns Ratio Meter uses:

Transformer Turns Ratio Meter is very useful as a tool for investigating problems associated with the core, the windings, and the tap changer of transformers and should be used for:

1. Identify shorted turns and finding turn errors
2. Defective and incorrect tap settings
3. Finding mislabelled terminals and mislabelled nameplates

Turns Ratio testing is a required test during the manufacture of transformers.

Turns Ratio testing is a part of a good routine preventative maintenance program as well as for Acceptance testing.

3.4.4 Limitations of Turns Ratio Testing:

In general, there are few limitations on ratio testing of Transformers. However, there are limitations to be aware of when attempting to test the following transformer:

- Phase relationships other than 30°
- Non symmetrical Zig Zag windings
- Off-center neutral points
- Suspected broken, damaged, or missing core laminations.

In the cases listed above, Raytech recommends the use of the optional unit; model T-Rex, in conjunction with the TR-Mark III 250V. To get further Information on the T-Rex please view the website; www.raytechusa.com or contact Raytech to get additional details and information.

Also, a **current transformer** is nothing more than an opposite wound voltage transformer. Most current transformers can be tested with the TR-Mark III 250V.

Please see chapter 'A.A Current Transformer Testing' for details about CT testing.

You may find it difficult to use the TR-Mark III 250V with some low power current transformers. In this case, please contact Raytech for information about a TR-1.



4 Quick Start Guide

4.1 Instrument operation



- ⇒ Wait until the green light shows “Safe” before handling the cables
- ⇒ If you are new to transformer turns ratio testing, please review the entire manual carefully before operating this equipment.
- ⇒ Examples for connections to the transformer see next pages
- ⇒ “Overcurrent” error may be displayed with some configurations.
- ⇒ It is OK to run through all the transformer selections with the leads tied together.

1. Switch on the instrument.
To repeat last Measurement, touch ‘GO ABC’. Touch ‘New’ to create a new transformer configuration.

11:23					
D:y-1		Ut=40V			
1U-1W:2U-2V2W			VR = - kV : - kV		
P	V Ratio	Dev [%]	I [mA]	P [°]	Pass
A	0.8660		0.0	+0.01	
B	0.8660		0.0	+0.00	
C	0.8660		0.0	+0.01	

Go ABC Go... Print Save

New Info Archive Setup

2. When ‘New’ is selected:
Select transformer type and Test Voltage, then touch ‘GO’.

Transformer Setup	
Yn : Δ 1	Utest 40V
<input type="checkbox"/> No Tap	<input type="checkbox"/> No Taps
<input type="checkbox"/> Tertiary	
10V	40V
100V	Auto
New	Load
Go Info	Go

3. Press ‘Go ABC’ or ‘Go...’ to start measurement.

11 32					
Yn:d-1		Ut=40V			
1U-1N:2U-2V			VR = - kV : - kV		
P	V Ratio	Dev [%]	I [mA]	P [°]	Pass
A					
B					
C					

Go ABC Go... Save

New Info Archive Setup

4. Get the results

11 32					
Yn:d-1		Ut=40V			
1U-1N:2U-2V			VR = - kV : - kV		
P	V Ratio	Dev [%]	I [mA]	P [°]	Pass
A	1.7320		0.0	+0.01	
B					
C					

Cont Stop



WARNING!

- ⇒ Do not touch the test clips while the safety indication is red. Test voltage will be present.



4.2 Connection to Test Object

4.2.1 Hooking up a transformer

This section describes a typical, step by step operation of the TR-Mark III 250V. Plug the TR-Mark III 250V into an available grounded outlet with 100/250 vac 50/60 Hz power source.

Connect the TR-Mark III 250V to the transformer under test with the coloured test leads and if required, use the Red 10 meter measuring lead extensions. The extensions will connect into the multicolour leads. Check the nameplate information of the transformer. If the nameplate is missing, it is still possible to test the transformer by a trial and error method. The TR-Mark III 250V test set is designed to detect errors in transformer hook ups. Contact the Raytech Service & Support department if you need assistance.



NOTE

⇒ No extra external leads or jumpers are required when using the TR-Mark III 250V. All necessary connections are made internally.

Single Phase Transformer

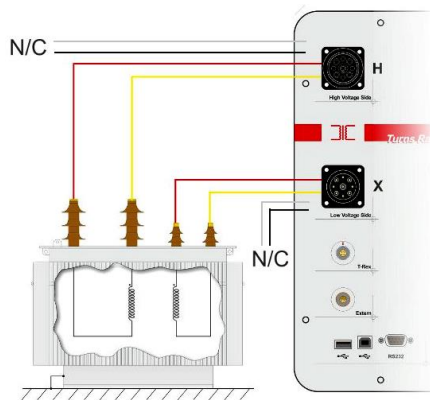

Three Phase Transformer

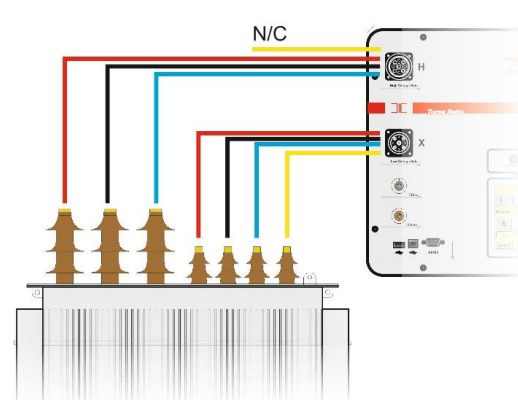

The colored leads are marked to indicate which transformer terminal it must be connected to for correct operation.

For a Single (1) phase transformer, use leads:

WIRE COLOR	ANSI	IEC	ANSI	IEC
- RED	indicates H1	U	phase (Red clip) or X1	u phase (Black clip)
- YELLOW	indicates H0	N	neutral(Red clip) or X0	n neutral (Black clip)

For a Single (1) phase auto-transformer, use leads:

WIRE COLOR	ANSI	IEC	ANSI	IEC
- RED	indicates H1	U	phase (Red clip) or X1	u phase (Black clip)
- Black	indicates H2	V	neutral(Red clip) or X2	v neutral (Black clip)

For a Three (3) phase transformer, use leads:

WIRE COLOR	ANSI	IEC	ANSI	IEC
- RED	indicates H1	U	phase (Red clip) or X1	u phase (Black clip)
- BLACK	indicates H2	V	phase (Red clip) or X2	v phase (Black clip)
- WHITE	indicates H3	W	phase (Red clip) or X3	w phase (Black clip)
- YELLOW	indicates H0	N	neutral(Red clip) or X0	n neutral (Black clip)



4.2.2 Comparison of International Standards

High Winding Side:

Wire Color	ANSI	Wire Color	IEC	Wire Color	Australian
RED	H1	RED	U	RED	A
BLACK	H2	BLACK	V	WHITE	B
WHITE	H3	BLUE	W	BLUE	C
YELLOW	H0	YELLOW	N	BLACK	N

Low Winding Side:

Wire Color	ANSI	Wire Color	IEC	Wire Color	Australian
RED	X1	RED	u	RED	a
BLACK	X2	BLACK	v	WHITE	b
WHITE	X3	WHITE	w	BLUE	c
YELLOW	X0	YELLOW	n	BLACK	n



NOTE

⇒ This manual refers to the ANSI standards for all examples. To change the standard in the test instrument please refer to chapter '8.6.1'



WARNING!

- ⇒ BEFORE OPERATING THIS OR ANY OTHER TEST EQUIPMENT READ ALL SAFETY WARNINGS AND UNDERSTAND THEM FULLY.
- ⇒ DO NOT VARY INPUT VOLTAGE (MAINS) AFTER POWERING ON TEST SET.
- ⇒ The TR-Mark III 250V auto-senses the input (mains) voltage from 100 to 250 vac 50 / 60 Hz.
- ⇒ The TR-Mark III 250V then "locks-in" the test voltage range. If the input voltage (mains) is varied after the TR-Mark III 250V was powered on the actual test voltage may be higher or lower than indicated.



5 Operation Elements

5.1 Front Panel Overview:

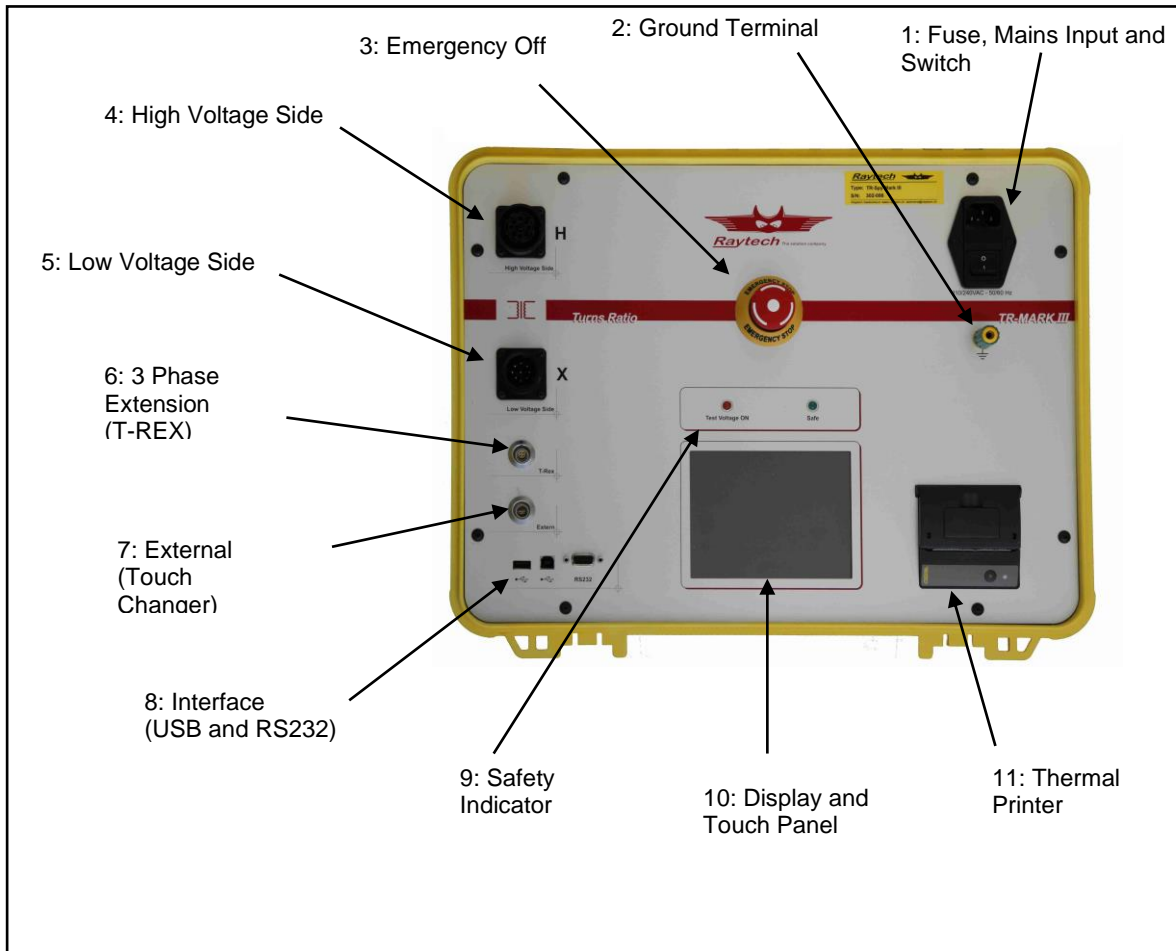

5.2 Control Elements and Connections

5.2.1 Fuse, Mains Input and Switch

A 2A fuse (slow blow) protects the device. Use only the correct fuse type to replace it.

5.2.2 Ground Terminal

Use this terminal to connect an additional ground line even if your mains Power cable (Mains) provides an Earth ground line. Also, use it even if you are not sure that the local installation Earth ground is a low resistive ground.

5.2.3 Emergency Off

Press to Stop. The system will halt and cease Voltage to the test leads immediately. Turn clockwise to release. The device will remain in a safe state.

5.2.4 High Voltage Side

The connector for the High side lead (H) to test object.

5.2.5 Low Voltage Side

The connector for the Low side lead (X) to test object.



5.2.6 3 Phase Extension (T-REX)

On TR-Mark III 250V, the T-Rex Interface is used to connect and control the optional T-Rex test set.

5.2.7 External

This port is used for an external connection to a tap changer dry contact. This port can also be connected to the optional external control switch- Part No. 1003N-31001 for utilizing the remote test start sequence.

5.2.8 Interface

RS232 and USB 1.1 Please see Chapter '10.1Hardware' for additional details.

5.2.9 Safety Indicator

Green Light on: No voltage applied to test leads. System is in safe standby mode.
Red light on: Indicates there is test voltage on test leads. System is testing.

5.2.10 Display and Touch Panel

TR-Mark III 250V can be easily manipulated and fully controlled by the touch screen panel. If preferred, an external mouse can be connected to the USB Port for system control.

5.2.11 Thermal Printer

Allows the user to quickly get results on paper by using the built-in thermal printer. The printer uses thermal heat transfer technology. Therefore, there are no ink cartridges required or printer heads. Special thermal paper is required for the printer to operate properly. Please note: The thermal paper must be inserted correctly in order to print. See below.



CORRECT



INCORRECT



6 Operation Elements Rack

Please find legend of elements on previous page.

6.1 Rack: Front Panel Overview

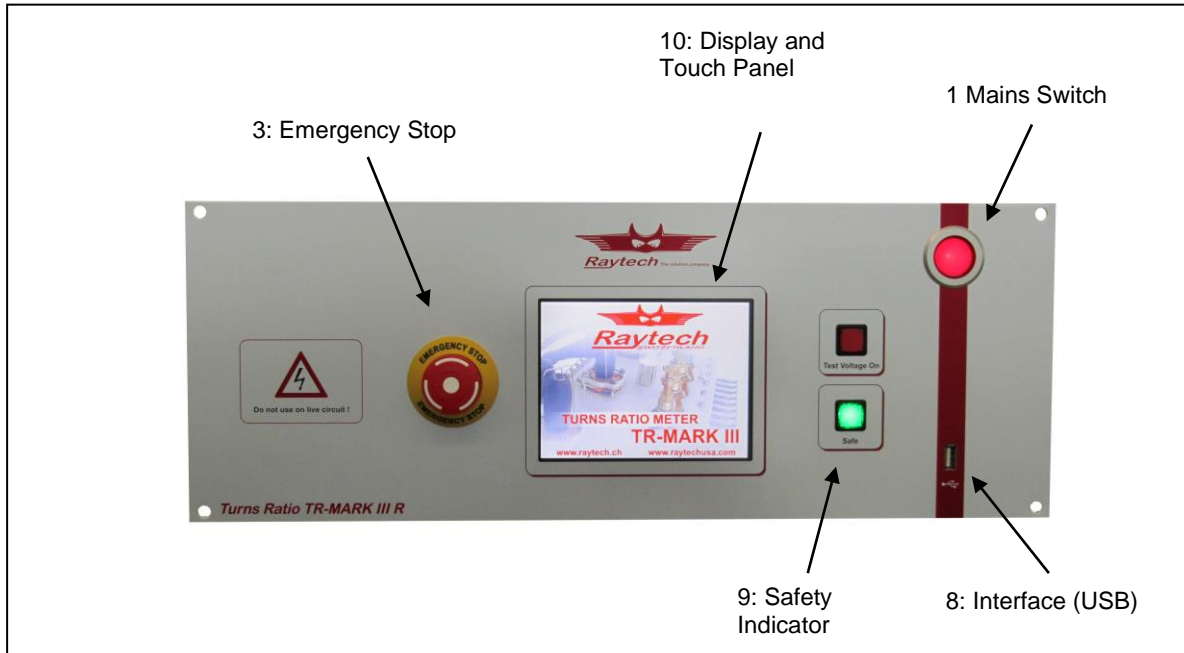

6.2 Rack: Rear Panel Overview

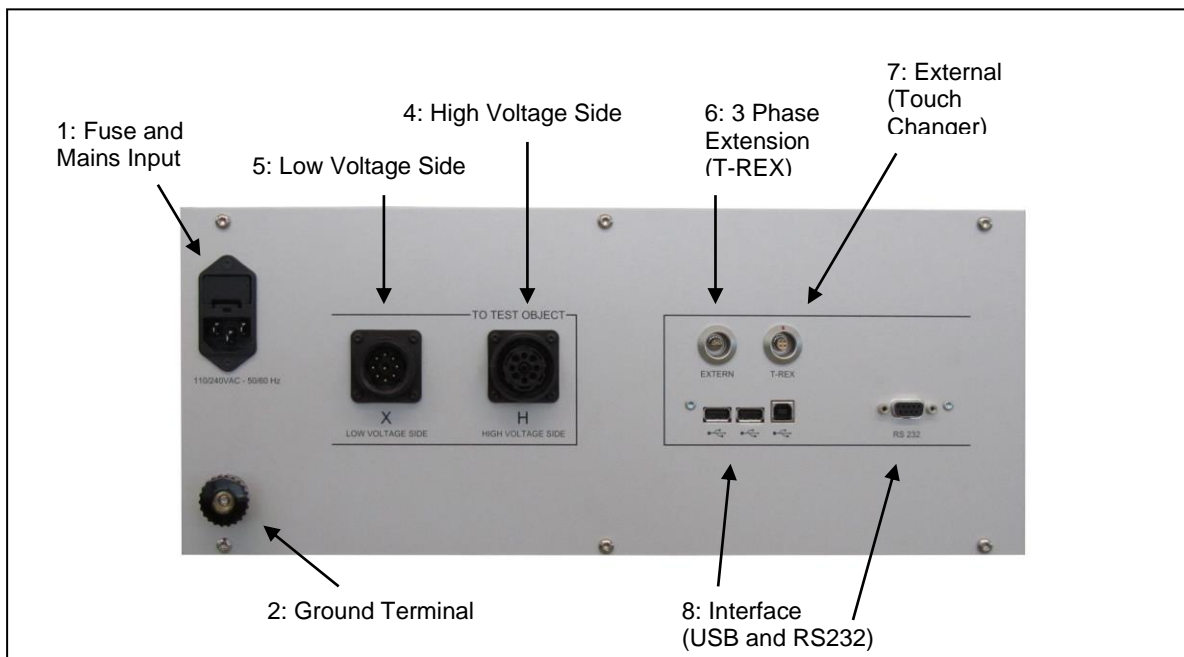



7 Transformer, Measurement and Data Structure

7.1 Introduction

There are thousands of instruments on earth that do a measurement and offer the possibility to store a measured value. This is a very useful feature which saves a lot of time and eliminates errors of writing down values by the operator. But still you have to do the handling and organization of the measured data on your own. This may introduce one day mistakes into your data set, especially when several measurements will be taken at once and sorted after words, or, if several operators use the same storage device.

7.2 How it works

With TR-Mark III 250V we offer another powerful tool that increases comfort in handling many transformers which are tested time after time. You do not have to sort a stored measurement anywhere. Once a transformer, or let us say a transformer profile is created, several measurements directly can be attached to it.

The profile or transformer contains the general (header) data. An attached result contains the measurement of all transformer phases. Or to define it more exactly:

A transformer / profile contains:

- Number of winding systems
- Type of winding systems
- Test voltage
- Rated voltages (primary, secondary, tertiary)
- Name plate info (name, serial number, location, manufacturer, type and remarks)
- Max. ratio deviation and standard (ANSI, IEC, Australian)

A measurement contains

- Measured results of all phases (ratio, deviation, current, phase angle)
- Date and time of all measurements

What you usually will do is creating a new transformer (profile), do a measurement and store it. In this case the profile and the actual measurement will be stored.

Or you load an existing transformer, do a measurement and store it. In this case, the new measurement will be attached or let us say stored with the loaded transformer.

Please find this illustrated on the following page.

NOTE



⇒ There is no difference between saving a transformer or attaching the actual measurement. Both are done with the button 'save' in the Main screen. See chapter '8.1.2.3

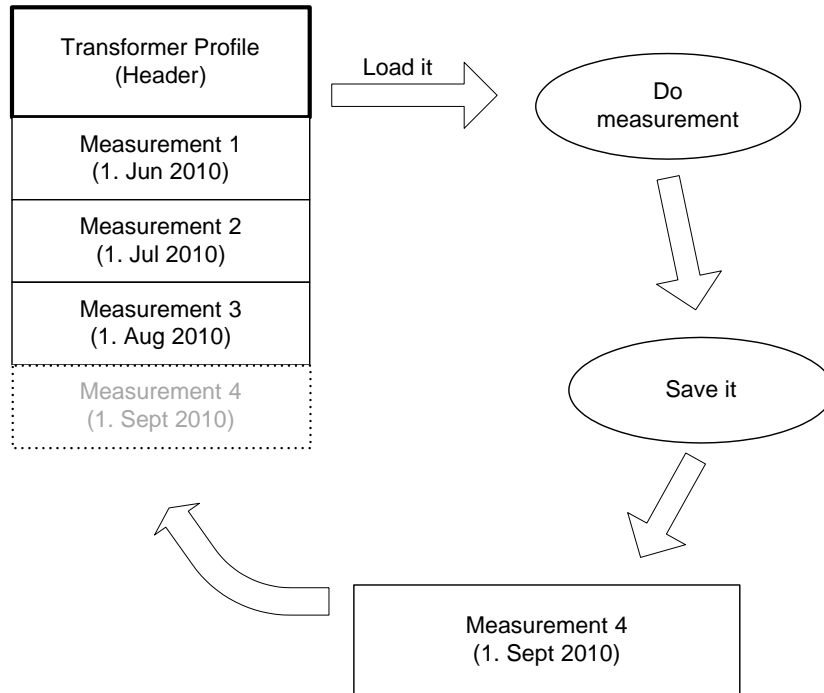

This shows a Transformer that has been created and measured for the first time on Jun 1th 2010. Profile and Measurement was saved by touching the 'save' button in Main Screen.

Then, this transformer was measured again, every 1th of a month. This means, that the transformer was loaded from archive again¹, measurement was done and the measurement was attached by touching the 'save' button in main screen.

In our example, now it is the 1th of September. And again, the transformer is loaded and measurement is done. This means, that a new measurement data block is created. And it is saved and attached by touching 'save'.

¹ Please see chapter '8.3.2 Load from Archive' or '8.5 Archive' for details



8 Operating Menu

TR-MARK III 250V Menu structured as shown in the figure below. Pressing a Cancel button, will bring you one layer towards Main Screen.

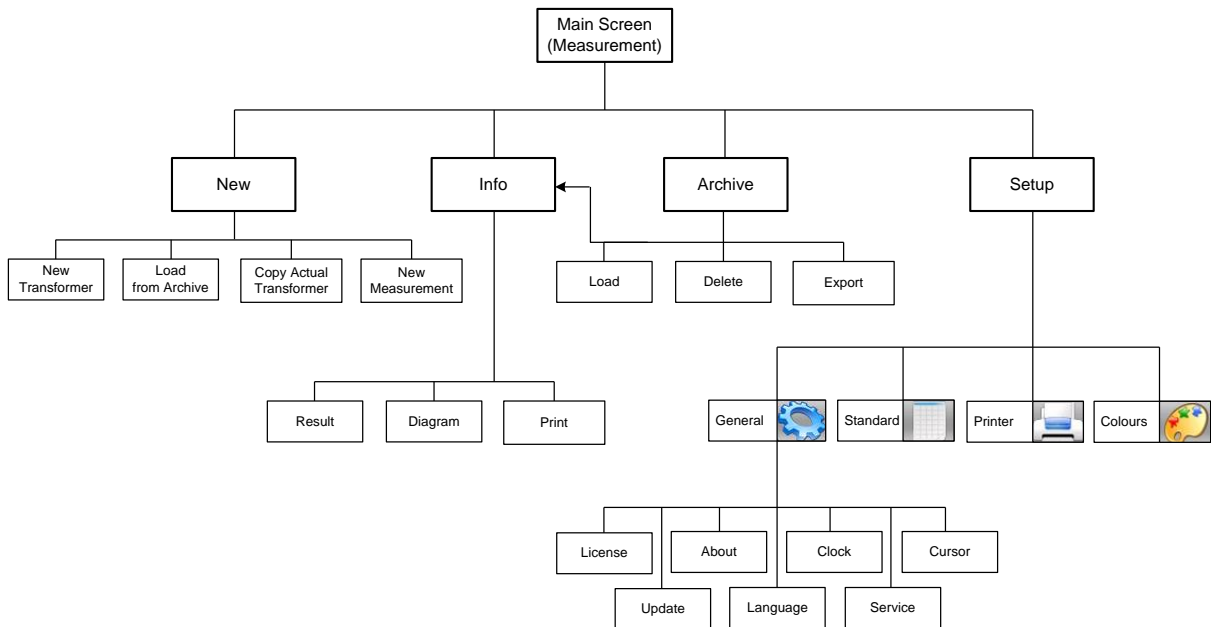



8.1 Main Screen

8.1.1 Operating on a simple screen, no Transformer Data entered

When a new Transformer configuration is entered into TR-Mark III 250V in the Setup screen and “GO” is pressed, the main test screen appears as followed:

P	V Ratio	Dev [%]	I [mA]	P [°]	Pass
A					
B					
C					

This Main Test Screen is the basic platform of the TR-Mark III 250V operation. On this screen, you will find buttons, indications and results.

Now let's start with the Go buttons. After connection to a transformer, Press “Go ABC” to measure all three phases A, B, and C in one cycle. The TR-Mark III 250V will automatically display any complete result per phase. After the test cycle, the main test screen will appear as followed:

P	V Ratio	Dev [%]	I [mA]	P [°]	Pass
A	1.0000		0.1	+0.00	
B	1.0001		0.1	+0.01	
C	1.0001		0.1	+0.00	

This is also the display you will find after switching on the instrument, if a measurement was finished before it was switched off.



If you are not up to measure all three phases at once, you can also touch 'Go...' to choose a phase to be measured in the appearing window. In this case no other phase than the chosen one will be measured.

P	V Ratio	Pass
A	1.0000	+0.00
B	1.0001	+0.01
C	1.0001	+0.00

This Option is also used to do a 'GO Tab' if you have tabs. Please see chapter '6.3.4' about how to define a transformer with taps.



8.1.2 Further Options of the Main Screen

8.1.2.1 Change Test Voltage

The following is further measurement settings that are provided by the main test screen.

The TR-Mark III 250V offers three Test Voltage settings. To change the Test Voltage, just touch on the button with the 'Ut=...' on the upper right side of the touch-screen. A selection window appears.

It is now possible to select a new Test Voltage by Selecting the button 'Ut=...'.

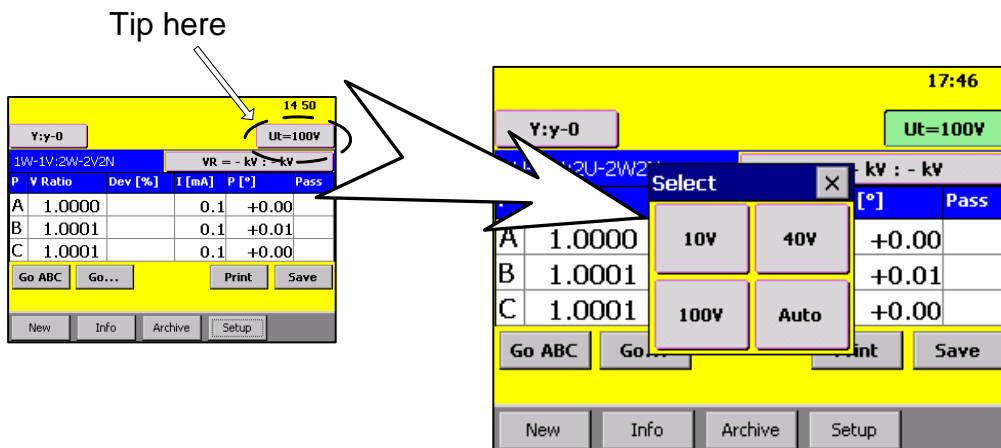

8.1.2.2 Stop Measurement and Continuous Measurement

On the TR-Mark III 250V, a scrolling progress bar indicates that a measurement is being made. In this condition the buttons on the lower part of the display disappear, and the two buttons "Cont" and "Stop" appear. Touch "Cont" (continuous) will lead to a continuous measurement of the marked phase.

In the continuous mode, the 'Cont' button will convert to a 'Next' button. This 'Next' button is used to switch to the next phase and stay in continuous mode.

Stop will immediately stop measurement in standard and continuous mode.

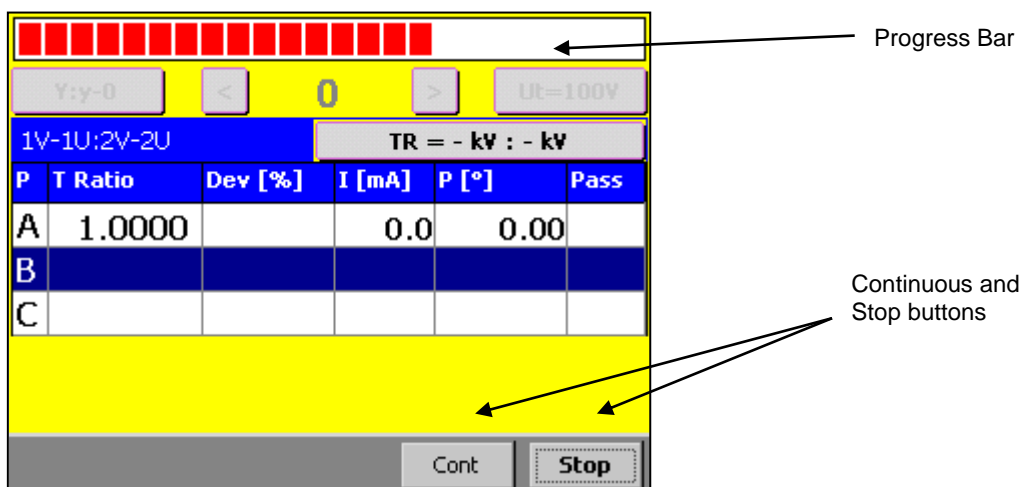



8.1.2.3 Turns Ratio or Voltage Ratio, Print and Save

Of course TR-Mark III 250V provides conversion of voltage ratio in to turn ratio. You can easily switch between these two options

After every measurement the results can be printed or stored. Use 'Print' and 'Save' to do so.



NOTE

⇒ 'Save' has only once an effect. To save several measurements, see chapter '8.3.4 New Measurement'.

Turns Ratio and Voltage Ratio:

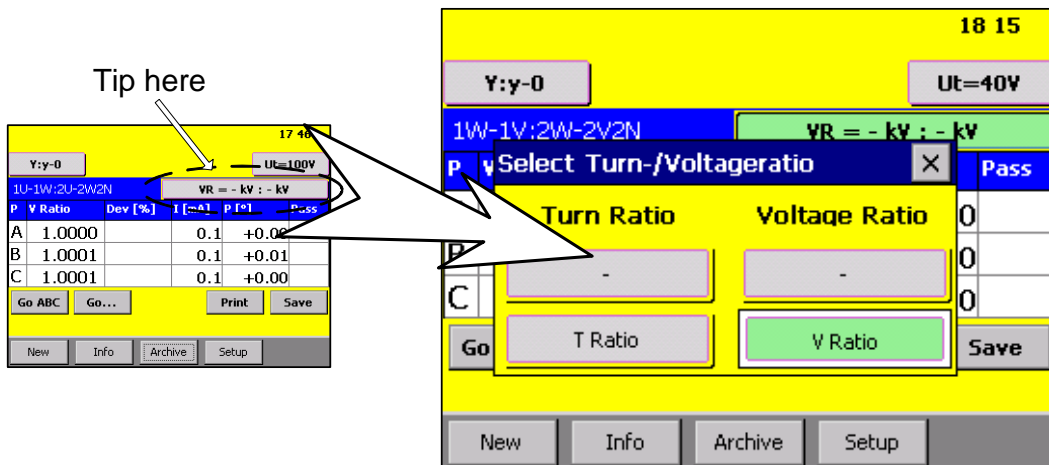



8.1.3 Operating on an advanced Screen, Transformer Data entered



NOTE

⇒ Please Check chapter '8.4 Info' if you are not familiar with entering and editing Transformer Data. Using Transformer Data may offer several benefits to you.

8.1.3.1 Pass, Fail and Transformer Name

When in 'Info' Rated Voltage Data are entered, Results are automatically checked. An indication for pass or fail is displayed for each phase. To provide more details, deviation appears in column *Dev*.

In chapter '8.4 Info', read about section 'General' for details about pass/fail criteria.

Pass:

18:36						
Y:y-0			Ut=40V			
1U-1W:2U-2W2N			VR = 1 kV : 1 kV			
P	V Ratio	Dev [%]	I [mA]	P [°]	Pass	
A	1.0000	0.00	0.0	+0.00	✓	
B	1.0000	0.00	0.0	+0.00	✓	
C	1.0000	0.00	0.0	+0.00	✓	

Go ABC Go... Print Save

New Info Archive Setup

Fail:

18:36						
Y:y-0			Ut=40V			
1U-1W:2U-2W2N			VR = 1 kV : 0.5 kV			
P	V Ratio	Dev [%]	I [mA]	P [°]	Pass	
A	1.0000	-50.0	0.0	+0.00	✗	
B	1.0000	-50.0	0.0	+0.00	✗	
C	1.0000	-50.0	0.0	+0.00	✗	

Go ABC Go... Print Save

New Info Archive Setup

When a Transformer Name is entered, it is displayed here

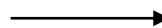

Transformer: 'Raytech Manual' 18:41						
Y:y-0			Ut=40V			
1U-1W:2U-2W2N			VR = 1 kV : 1 kV			
P	V Ratio	Dev [%]	I [mA]	P [°]	Pass	
A	1.0000	0.00	0.0	+0.00	✓	
B	1.0000	0.00	0.0	+0.00	✓	
C	1.0000	0.00	0.0	+0.00	✓	

Go ABC Go... Print Save

New Info Archive Setup



8.1.3.1 Turn Ratio and Voltage Ratio

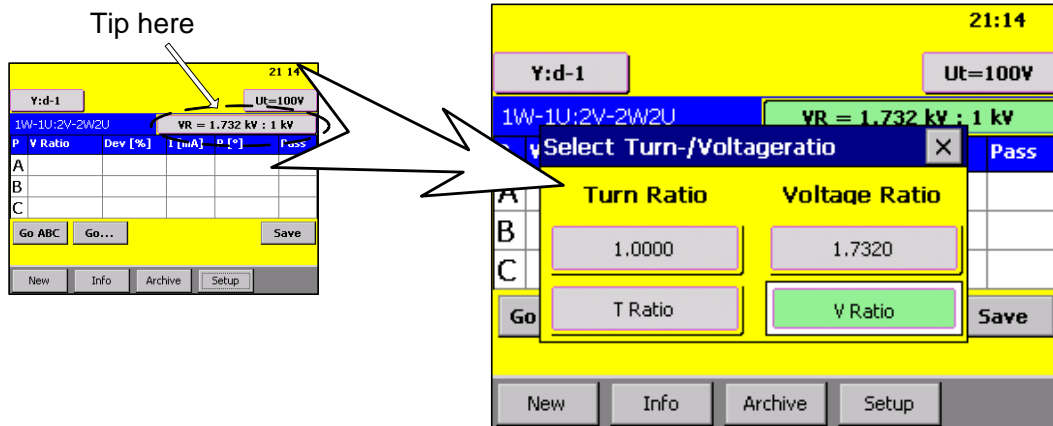

To simplify your work, we provide up to four display options for the entered transformer data. The buttons 'T Ratio' and 'V Ratio' will lead to a non-calculated view. That means that you will get for instance nominal voltages instead of a calculated ratio displayed. The buttons with a number will directly display the calculated nominal ratio, based on data in the info field.

The following example shows a D:y Transformer and what display options TR-Mark III 250V provides:

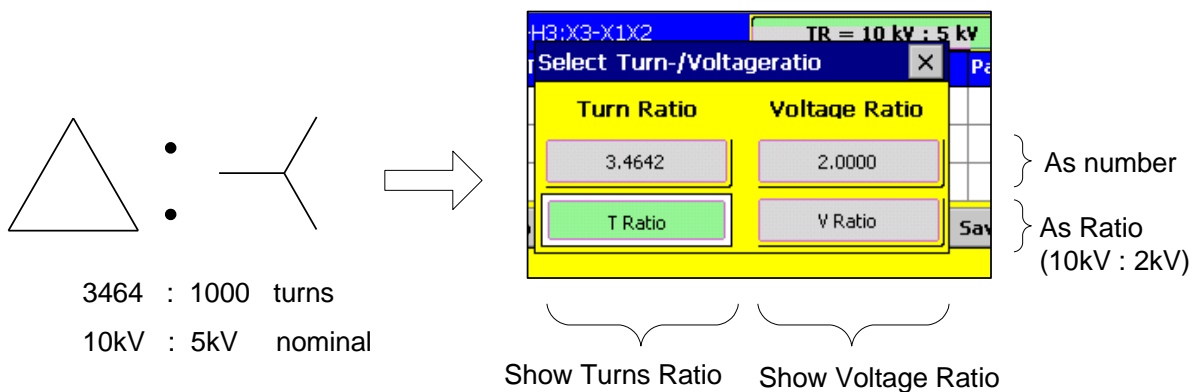



8.1.4 Taps

As its forerunner, TR-Mark III 250V provides tap changer control.

The following Screens show a transformer with a fully filled info field. If you do not fill it out, some shown information may not appear, but the screen keeps the same functionality.

On the upper part of main screen, the actual tap step is displayed as a number. It is easy to measure through several or all tap steps. Besides are buttons, to switch one step up or down.

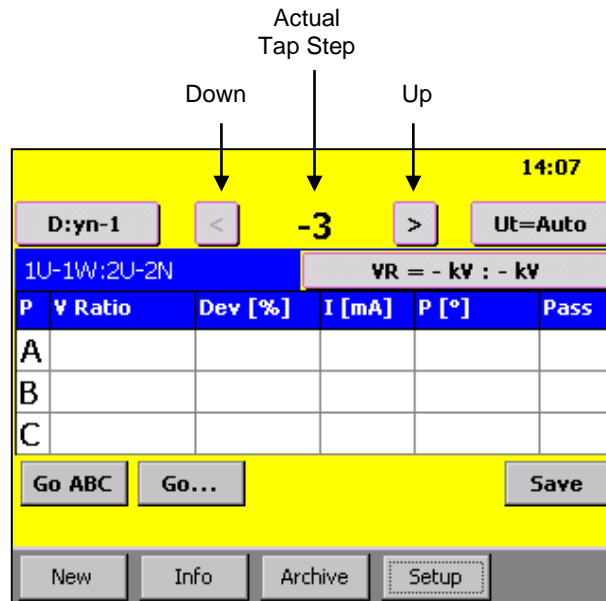

You may wish to know what for instance “tap 5” means in volts. Or you would like to switch to the 22kV Tap. Both can be done easily by touching the ‘Actual Tap Step Number’ (-3).

In the following window tap number and corresponding voltage is displayed. To give you an overview of all taps, a complete with corresponding voltages is also available.



How to choose taps by nominal voltage:

The image shows a sequence of three overlapping screenshots from a software application, illustrating the process of selecting a tap based on nominal voltage. The top screenshot shows a main window with a tap of -3 selected, indicated by a dashed circle and an arrow. The middle screenshot shows a 'Select Tap Changer' dialog box where the tap -2 (9.800kV) is selected, also indicated by a dashed circle and an arrow. The bottom screenshot shows a 'Select Tap Changer Secondary' dialog box with a table of available taps, where the tap -2 is highlighted.

Name	U Nom [kV]
-3	9.7
-2	9.8
-1	9.9
0	10
+1	10.1
+2	10.2



8.1.5 More Taps

You may find Transformers with tap changers on primary and secondary winding system. TR-Mark III 250V helps you to handle this too. Now let us see what happens, when we enter in chapter '7.2.1.2 Taps' a Transformer with taps on both sides.

The free tap step can be with '<' and '>' as described in chapter '7.1.4 Taps'. And too as described there, you can open a tap changer menu, by touching the displayed tap number. This menu is also used, to change the fixed tap step.

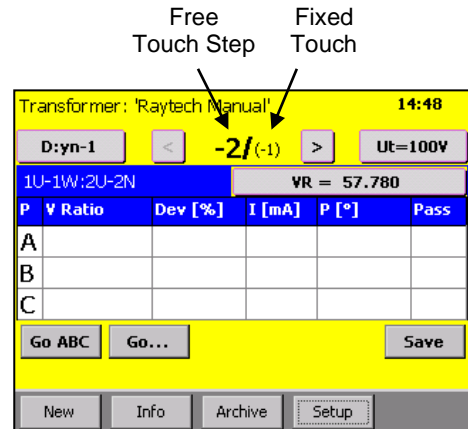

How to handle primary and secondary taps and nominal voltages:

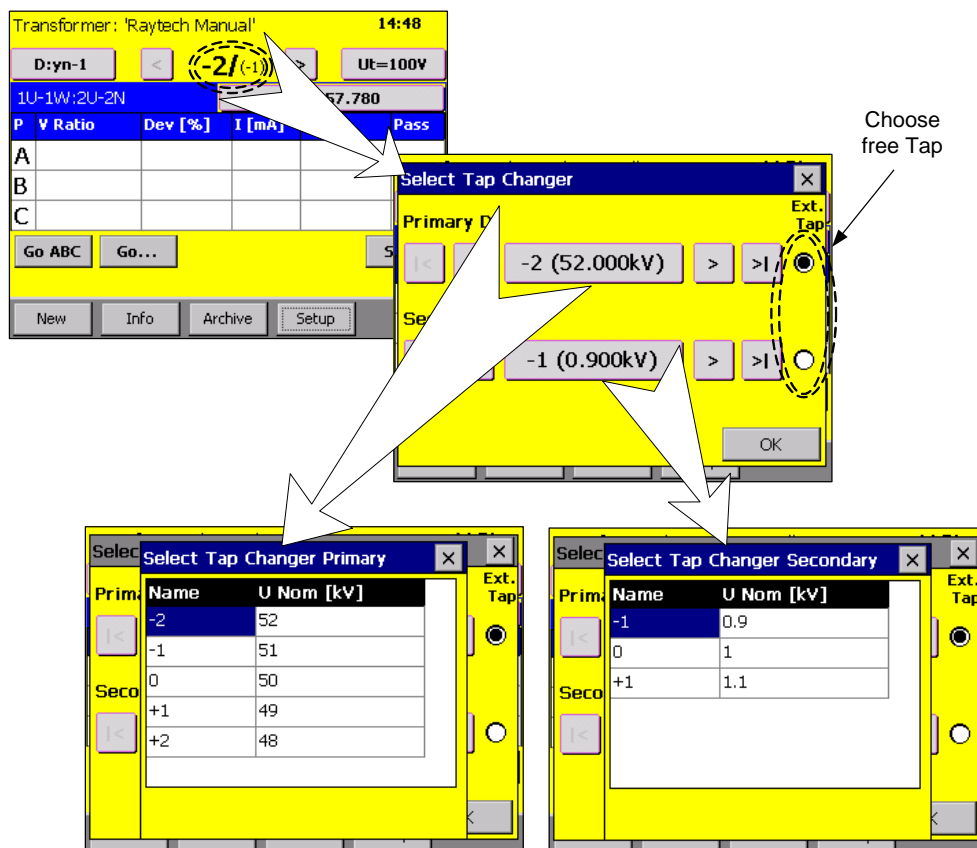



8.1.6 Tertiary Winding System

A really unusual transformer may have a primary, a secondary and a tertiary winding, and several taps on each winding. That's not a problem when you are using a TR-Mark III 250V. A few buttons will give you control and overview over the complete measurement of such a transformer.

You may have asked yourself before, what the button on the upper left on main screen is used for. And why it is a button and not just a Text. The answer is in case of a tertiary winding system, it is used to switch between the ratio primary to secondary and primary to tertiary.

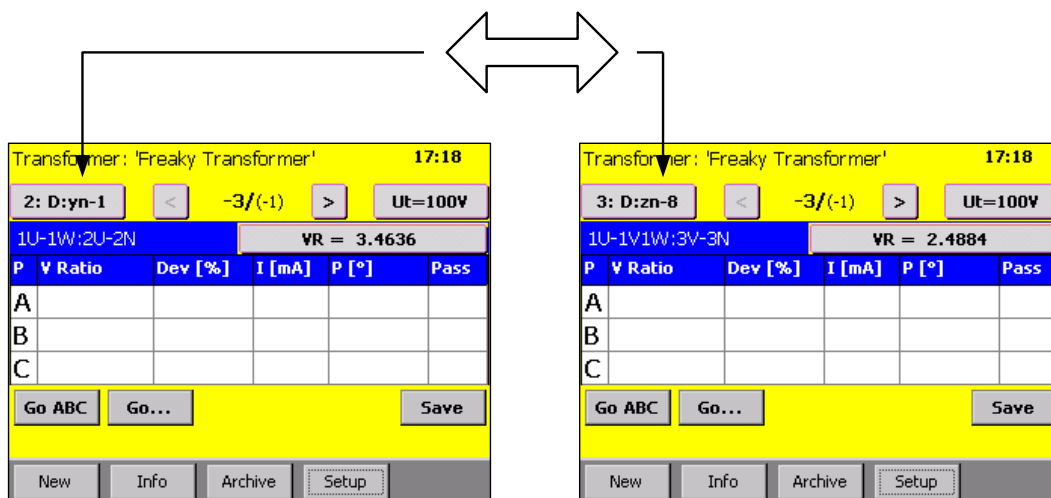

Also take notice of what happens with the tap changer display. As explained in chapter '7.1.5 More Taps', the fixed tap is displayed smaller and in braces, while the free taps appear bigger and bold. As you switch the X-Side from secondary to tertiary, the fixed tap changes also.



And now let us have a look how tap changer control works in this case.

Touch on tap changer display as described in chapter '7.1.5 More Taps', and you will find yourself in front of the same screen.

The main difference is only the moment you switch to tertiary winding system.

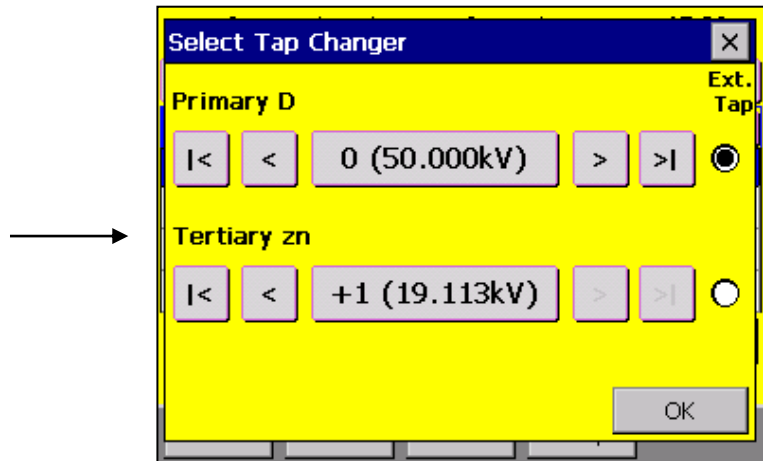

Of course you can also assign tertiary tap changer to be free.

Just be aware, that TR-Mark III 250V automatically sets the primary tap changer to be free, when you switch back to secondary winding system on the X-Side.



8.2 New

TR-Mark III 250V offers an improved data structure and handling to support your needs. When the button 'New' in main screen is pressed, the user is asked what he wants to do by offering the four buttons showed below.

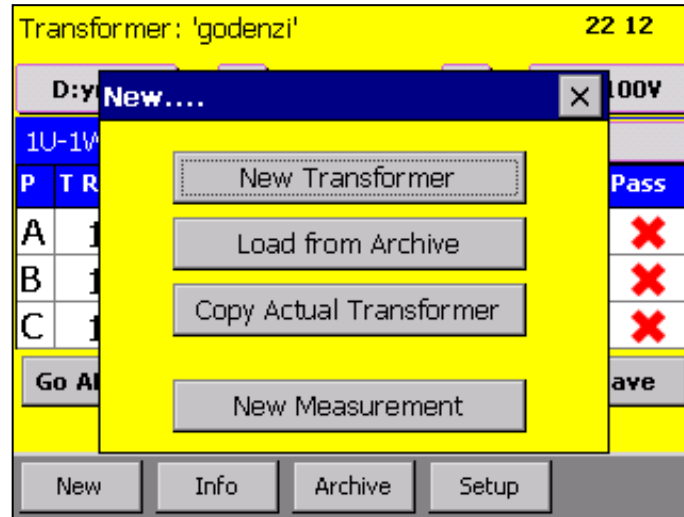

NOTE

⇒ Please check chapter '7' for detailed information about data structure of TR-Mark III 250V



8.2.1 New Transformer

This button will start the procedure of creating a new transformer. If the last used Transformer or measurement is not saved yet, you will be asked if you like to do so.

8.2.1.1 Simple Transformer, no taps

The TR-Mark III 250V sets the focus on the first winding system. Choose the type corresponding to your transformer from the menu shown below. The system will accept it and set the focus automatically to the next input button.

Touch the button below 'Utest' to choose your test voltage.

Finally, touch 'GO' to get to main screen and start measurement.

Touch 'Go Info' to go to the main screen via the info. menu, if you would like to enter transformer details.

'-> Temp' will store the new transformer as a template. Please see chapter '8.2.5 Working with Templates' for details information

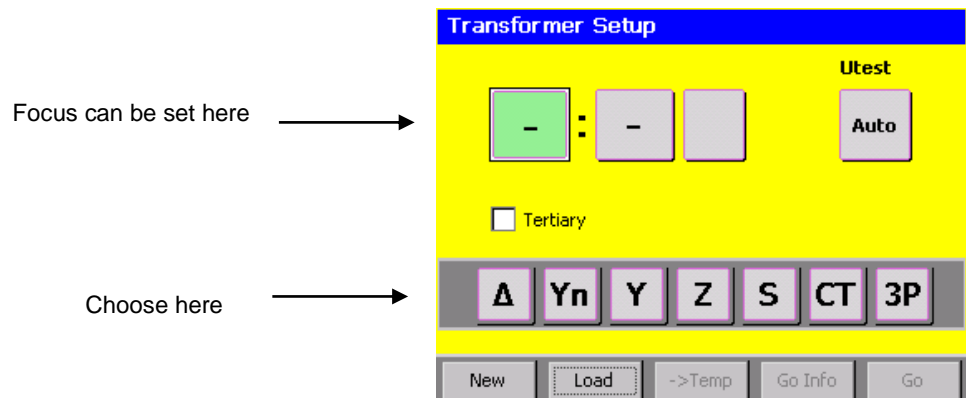



8.2.1.2 Taps

For every winding system taps can be defined. Just touch on the check box by sides the text 'No Tap' below to the transformer coil where you want to enter taps. Then a screen to define tap steps appears.

Use '<' or '>' to increase or decrease first and last tap step.

tip here

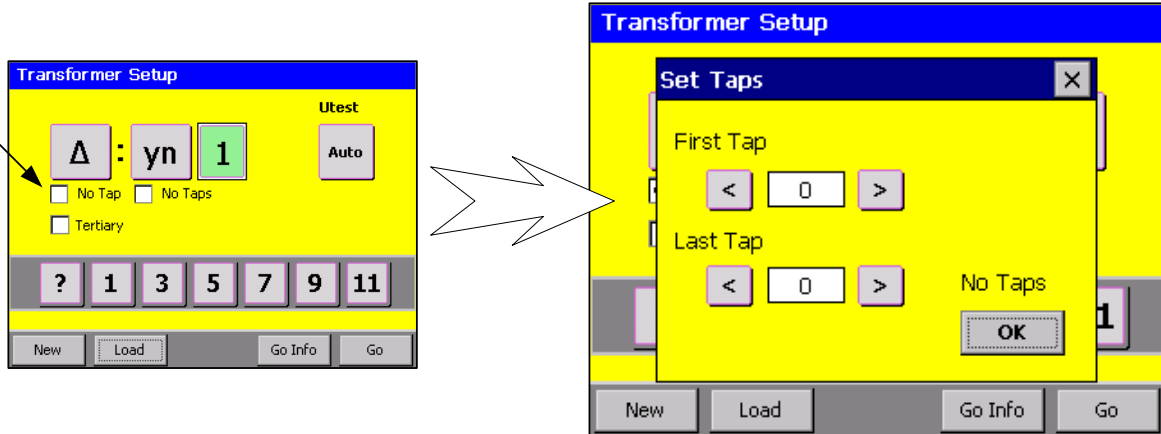

Press 'OK', and chosen tap will be displayed.

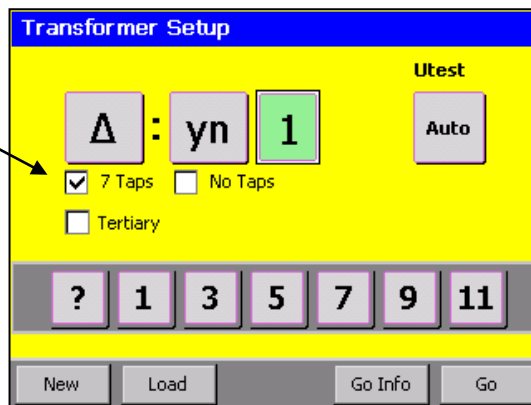

Your Transformer may have taps on the primary and on the secondary winding system. Use the same procedure to define the secondary taps.



NOTE ⇒ Please Check chapter '8.4' for detailed information about how to assign voltages to tap steps



8.3.1.1 Tertiary Winding System

Don't worry about transformers with three winding systems. Just activate the 'tertiary' option, by touching the checkbox. Then the buttons for one more coil appears. And of course you can also define taps for this third winding system.

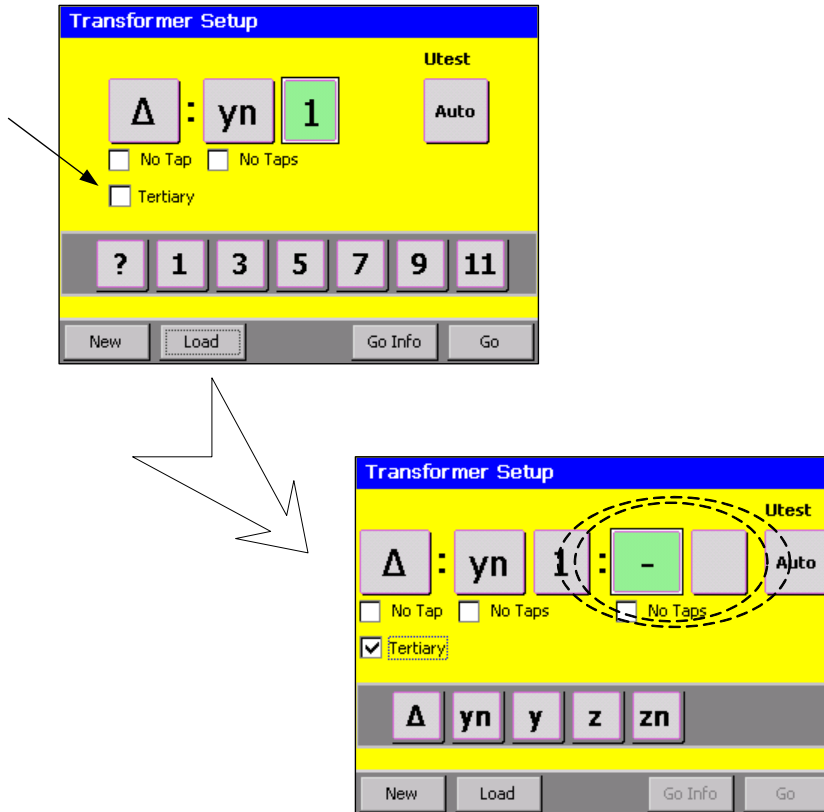



8.3.2 Load from Archive

You may already have the transformer you are up to measure stored on TR-Mark III 250V or on a memory stick.

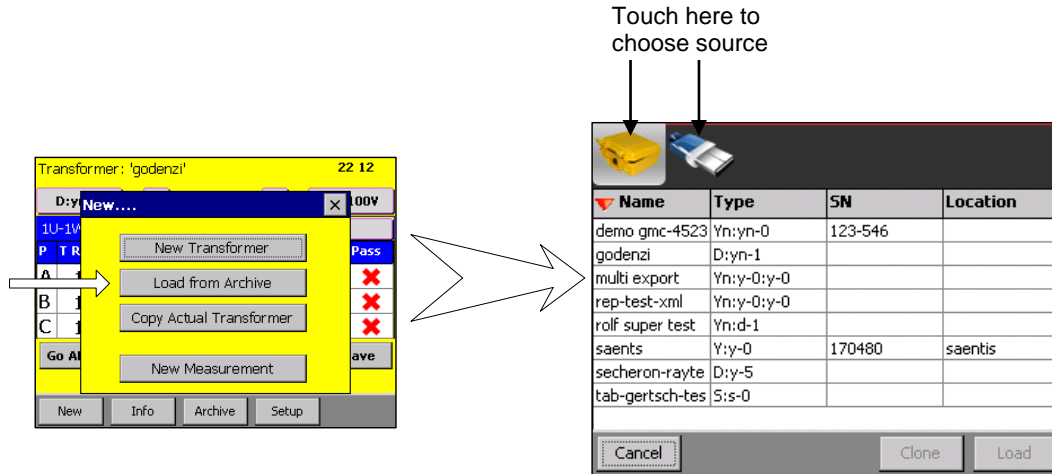

In the Archive screen, make your choice by touching on a transformer with your finger. Touch 'Load' to load it and append your measurement. Touch 'Clone' to create a new transformer, based on the one you have chosen.

Touch on the pictures on top (TR-Mark III 250V or memory stick) to choose between the sources. The memory stick will only be displayed if connected.



8.3.4 New Measurement

As described in chapter 7 Transformer, Measurement and Data Structure', the TR-Mark III 250V has only one measurement present at time. Starting the measurement process again, will result in overwriting the results on the screen. Tapping the 'save' button several time will have no effect

If you are up to do several measurements and save them, use the 'New Measurement' option.

You will be asked to save your present measurement, if you did not yet do so. Afterwards the results on screen will be erased. And after a new 'Go ABC' or 'Go...', you can attach further measurement to a transformer, by tapping 'save'.

8.3.5 Working with Templates

As described in Chapter'8.2.1 New Transformer', a new transformer profile can be created as a template. What does that mean?



NOTE

⇒ Use this option, if you have to measure many transformers of the same type.

The new profile will be created with a minimum of information, and it will be stored in the archive of TR-Mark III 250V. In the info field 'serial number', 'Template' will automatically be entered, and you will be asked to give a Name to the transformer.

This Template can be cloned via Archive menu. Then TR-Mark III 250V creates a transformer profile based on the template. You will be asked to enter a new transformer name and a serial number. After entering this information you will be led to main menu and measurement can directly be started.



8.4 Info

This screen has three goals:

- Helping the operator to identify Transformers
- Feeding TR-Mark III 250V firmware with information, to improve its output.
- Viewing and printing of results

And it contains four sections. The sections are chosen by touching their name on the left side of the screen.

- **Rated voltage:**
Here primary and secondary, and if available tertiary voltage can be entered. TR-Mark III 250V automatically calculates voltage and turn ratio based on these entries. Voltages on Tap changers can be defined manually or automatically by a wizard. See picture above.

Transformer Info		
Rated Voltage	Primary D	Taps -2...+3
	U Nom	0.00..0.00 kV
Name Plate	Secondary y - :Taps -1...+1	
General	U Nom	0.00..0.00 kV
Actual Result		
Result Diagram Print OK		

- **Add Info:**
This section especially helps to identify a transformer. Data like transformer name, serial number, manufacturer, type and so on can be entered and displayed.

Transformer Info		
Rated Voltage	Name	<input type="text"/>
	S/N	<input type="text"/>
Name Plate	Location	<input type="text"/>
General	Manufacturer	<input type="text"/>
Actual Result	Type	<input type="text"/>
	Remarks	<input type="text"/>
Result Diagram Print OK		

- **General:**
Maximal Ratio Deviation can be set in this chapter. By default it is 0.5%. That means, if the measured ratio deviates more than 0.5% from the theoretical value, the measurement will be designated as “failed”. Here you can also define which transformer standard is used. (IEC, ANSI, Australian)

Transformer Info		
Rated Voltage	Max Ratio Dev.	0.5 %
	Standard	ANSI
Name Plate		
General		
Actual Result		
Result Diagram Print OK		



- Results
A sorted List of results and graphics are available.

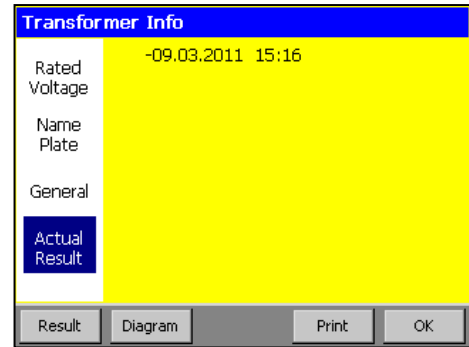

NOTE

⇒ Depending, if you start this screen from Archive or from Main Screen, and if you are the owner of a transformer, it will be read only or read/write.
When started from Main Screen, in chart 'Results' will be named as 'actual Result' and it will only show the actual result.



8.4.1 Enter Tap Changer Data by Wizard

Touch in 'Info' Menu on the button by sides "U Nom" to enter tap changer data manually or by wizard.

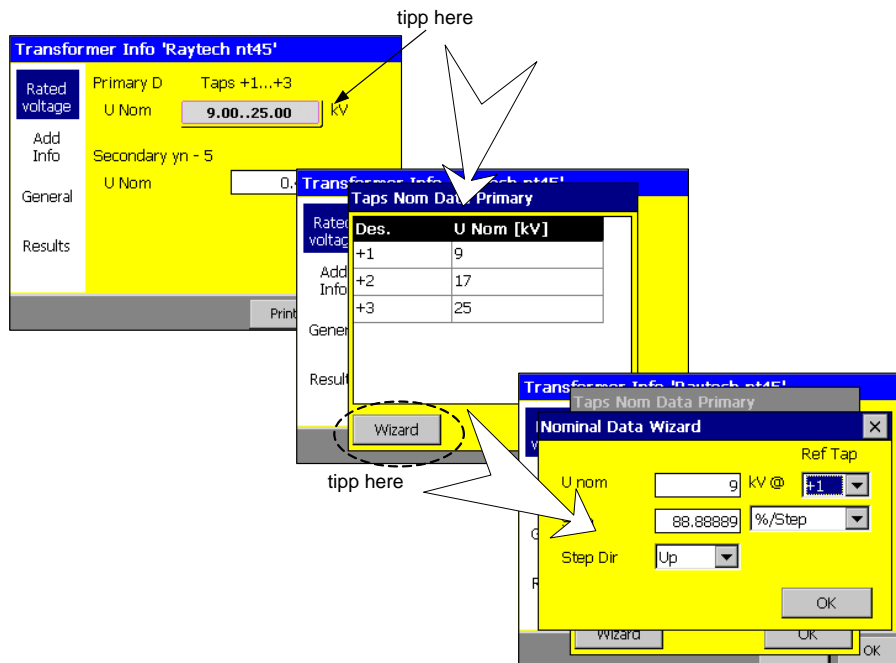

8.4.2 Enter Tap Changer Data manually

You can anytime enter corresponding voltages to taps manually. You may use this for instance when your tap steps are not linear. Just push on the field you like to edit. The editor works for designator and voltage.

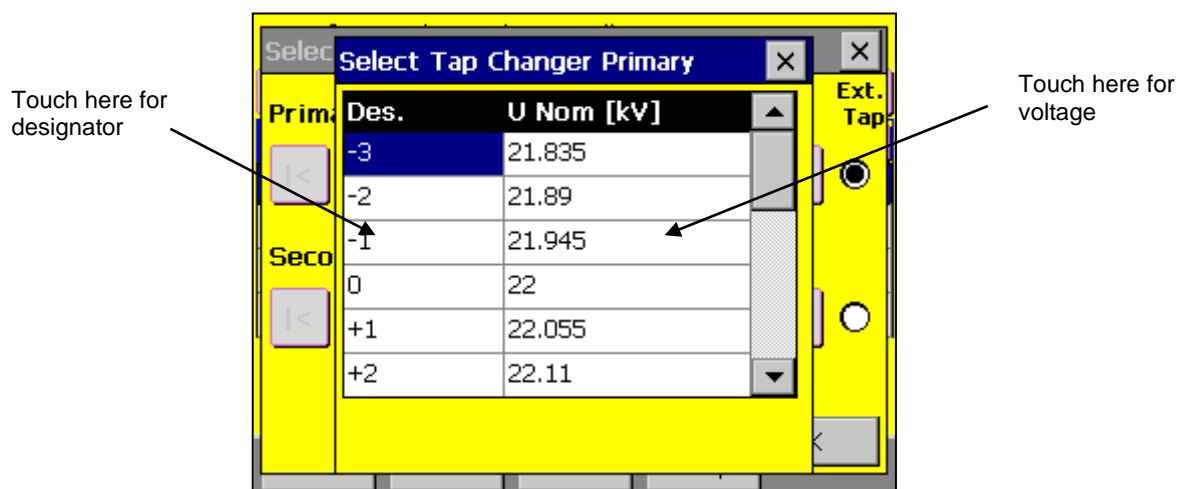



8.5 Archive

The 'Archive' menu is used to load, delete, import, or export as well as show information of Data on TR-Mark III 250V. Of course, the import and export feature can only be used when a memory stick is connected to USB port on the Mark III.

No memory stick connected.

Name	Type	SN	Location
trex-GTR	3P:3p-0		
testllll	Yn:d-1		
Raytech nt45	D:yn-5	476345	
kkju	Yn:d-3;y-2		
demo gmc-4523	Yn:yn-0	123-546	
1/1/2000	Yn:yn-0		
1/1/2000	Z:yn-1		

Cancel Select All

Memory stick connected.
Touch here to switch to memory stick.

Name	Type	SN	Location
trex-GTR	3P:3p-0		
testllll	Yn:d-1		
Raytech nt45	D:yn-5	476345	
kkju	Yn:d-3;y-2		
demo gmc-4523	Yn:yn-0	123-546	
1/1/2000	Yn:yn-0		
1/1/2000	Z:yn-1		

Cancel Select All

Touch on the lines to select one or several transformers.

As soon as one transformer is selected, it will be highlighted and function buttons in the bottom menu appear. If two or more lines are highlighted, 'Load' and 'Info' of course will disappear again.

Name	Type	SN	Location
trex-GTR	3P:3p-0		
testllll	Yn:d-1		
Raytech nt45	D:yn-5	476345	
kkju	Yn:d-3;y-2		
demo gmc-4523	Yn:yn-0	123-546	
1/1/2000	Yn:yn-0		
1/1/2000	Z:yn-1		

Cancel Load Delete Export Info

Selected Measurement

Function Buttons



8.6 Setup

Setup menu contains the following four parts:

- General
- Standard
- Colors
- Operators
- Printer

They can easily be switched with the symbol taps on top of the screen. The content of these four parts is described in the following chapters.

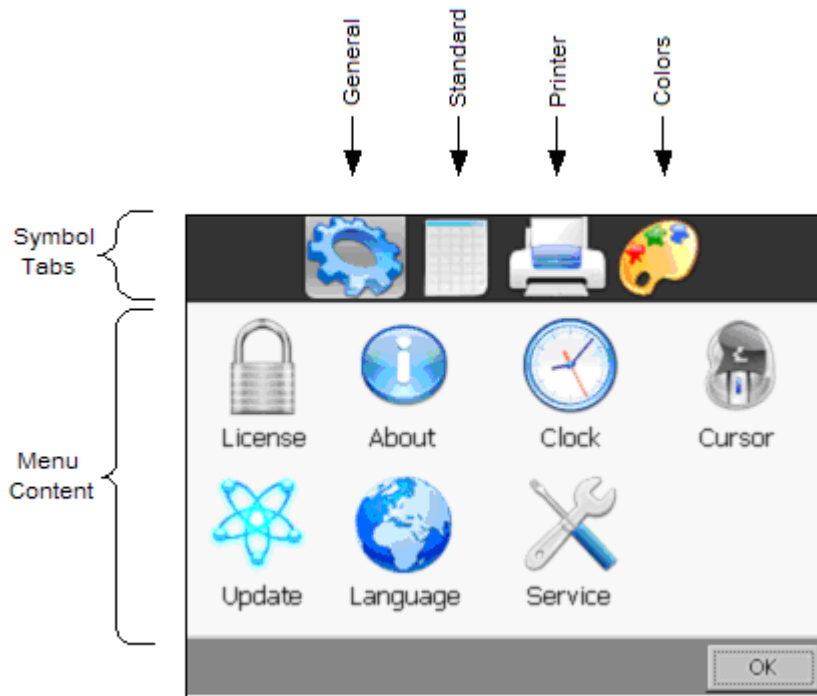



8.6.1 General



8.6.1.1 License

License Manger is used to enter a Raytech License Number. If your license state changes, you may be asked to enter a new License.

This menu displays the actual license state. Press the 'Enter New License Key' button to enter a new License key number.

8.6.1.2 About

Choose this menu to get information about the instrument like Firmware version and Serial number of the test system.

8.6.1.3 Clock

Use this menu, to set the date and time. This is important because your measurement will contain a time stamp that will be saved to memory.

8.6.1.4 Cursor

This option is important when using a USB mouse. Use it to switch the cursor on or off.

8.6.1.5 Update

Raytech is always improving their products. Firmware updates may be available. Check the Raytech website or contact Raytech for the latest update. These are provided at no charge. The easiest way to receive an update is to save the newest version on a USB memory stick. Then connect the USB memory stick to the instrument. The new version will automatically be detected and the system will ask if you wish to update. If selected, this update process is then fully automatic. In some cases it may be necessary to initialize the update manually.

8.6.1.6 Language

TR-Mark III 250V firmware supports several languages. Use this menu, to choose your favorite language from a list of available languages.

8.6.1.7 Service

Only qualified personnel should access and service Raytech equipment. A service code is required to obtain access to special service menus.



8.6.1 Operators



Every measurement can be stored with the name of the actual operator. In this menu, new operators can enter their first name and last name. Existing entries can be changed.

Touch an operators name and then touch 'ok' to make your choice.

Note the 'Ask for Operator at Power-up' check box. When checked, you will be asked if the chosen operators name is yours. This may be helpful, when several operators are using the same TR-Mark III 250V.

8.6.2 Standards



TR-Mark III 250V supports several international transformer standards. Use this menu to choose the one you prefer.

8.6.3 Printer



If you are up to use an external USB Printer, you should choose the correct emulation. Connect your USB Printer to TR-Mark III 250V's USB host connector². Maybe you would like to print a test page, to make sure everything works properly.

To use the auto print option on the internal printer, choose this option in printer menu.

8.6.4 Color



Two recommended color schemes are available. Indoor and in moderate sunlight you may prefer the colored scheme.

In bright sunlight black and white provides maximal contrast to make sure everything stays readable.

² The USB host has an oblong connector, USB device has square connector.



9 Technical Specification

Measurement Parameters

Ratio: Resolution: 5 Digits

250V	Range		
	0.8 ... 5000	±0.06%	Rdg ±1 LSD
	5001...10,000	±0.1%	Rdg ±1 LSD
	10,001.. 32,500	±0.3%	Rdg ±1 LSD
	32,501...40,000	±0.4%	Rdg ±1 LSD
100V,	Range	Accuracy at 100 V or 40 V	
40V	0.8 ... 2000	±0.06%	Rdg ±1 LSD
	2001 ... 4000	±0.1%	Rdg ±1 LSD
	4001 ... 13000	±0.3%	Rdg ±1 LSD
	13000 ... 16000	±0.4%	Rdg ±1 LSD
10V	Range	Accuracy at 10 V	
	0.8 ... 500	±0.1%	Rdg ±1 LSD
	501 ... 1000	±0.12%	Rdg ±1 LSD
	1001 ... 3250	±0.3%	Rdg ±1 LSD
	3251 ... 4000	±0.4%	Rdg ±1 LSD
1V	Range	Accuracy at 1 V	
	0.8 ... 50	±0.1%	Rdg ±1 LSD
	51 ... 100	±0.15%	Rdg ±1 LSD
	101 ... 325	±0.3%	Rdg ±1 LSD
	326 ... 400	±0.4%	Rdg ±1 LSD

Current:

Range	Accuracy	Resolution
0 ... 1A	±0.001 A	0.1mA

Phase Angle: Phase Range: ±90 Degree, Resolution: 0.01°

250V	TR-Range	Accuracy
	0.8 ... 600	±0.05°
	601 ... 5,000	±0.10°
	5,001...10,000	±0.15°
	10,001...32,500	±0.40°
	32,501...40,000	±0.50°
100V	TR-Range	Accuracy
	0.8 ... 240	±0.05°
	241 ... 2000	±0.10°
	2001 ... 4000	±0.15°
	4001 ... 13000	±0.40°
	13000 ... 16000	±0.50°
40V	TR-Range	Accuracy
	0.8 ... 240	±0.10°
	241 ... 2000	±0.15°
	2001 ... 4000	±0.20°
	4001 ... 13000	±0.45°
	13000 ... 16000	±0.55°
10V	TR-Range	Accuracy
	0.8 ... 60	±0.15°
	61 ... 500	±0.25°
	501 ... 3250	±0.55°
	3251 ... 4000	±0.65°
1V	TR-Range	Accuracy
	0.8 ... 6	±0.15°
	7 ... 50	±0.25°
	51 ... 325	±0.55°
	326 ... 400	±0.65°



Specifications

- Model TR-Mark III 250V
- Size L: 470 mm (18.5") W: 371 mm (14.6") H: 190 mm (7.5")
- Weight: 9.5 kg (21 lbs.)
- Input Power 100 to 250 Vac 50/60 Hz auto ranging. Fuse: 2A
- Test Voltage User Selectable: 250, 100, 40, 10, and 1Vac.1A
- Panel Display Color LCD with back lighting and touch screen
- Front Panel Sealed Anodized
- Interface 2 USB 1.1 (1 host/1 device) and 9 Pin RS232 serial
- Memory Storage Internally stores more than 10,000 test results
- Temperature Operating -10°C to 60°C , Storage -20°C to 70°C

Accessories

- Complete cable set (consisting of a 5 m cable with an extension cable of 10 m), Safety ground lead, power cord, cable carrying bag, instruction manual, USB memory stick, USB Cable (Type A-B), RS-232 cable, printer paper refills, stylus, spare fuse set

Options

- P/N: 1003N-31001 - External test switch for Tap changer testing
- T-Rex 3-phase voltage option to energize all 3 phases at once
- TR-Mark III 250V R 19", 4U Rackmount version

* Specifications are subject to improvement at anytime



10 Interfaces

10.1 Hardware



1 x **RS232**, 9 Pin

Pin 2 TxD (WR100-> Host)
 Pin 3 RxD (Host-> WR100)
 Pin 5 GND

Interface Parameters:
 (fixed, unchangeable)

Port RS232
 Baudrate 19200Baud
 Databit 8 Bit
 Stopbits 1 Bit
 Parity No

1 x **USB-Master** 1 x **USB Slave**

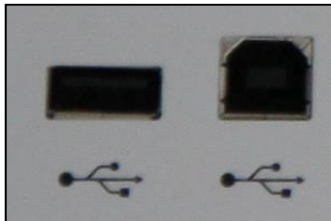

Standard 1.1



1 x **T-Rex Extension**

Pin 1: trex_D0
 Pin 2: trex_D1
 Pin 3: trex_Busy
 Pin 4: GND

Extern / Tap Switch

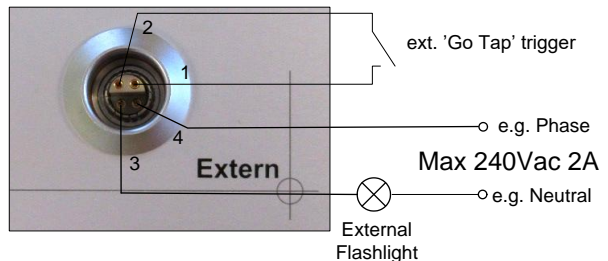

example for **external warning device**

TR-Mark III 250V offers 1 relay contact between Pin 3 and Pin 4.
 Pin 1 & 2 is the Tap Changer input. Shorten those two pins by a working contact to start measurement when using 'Go Tap'.



10.2 Raytech Toolbox

The Raytech Toolbox is for Data Exchange between the measuring instruments and an external computer.

The Raytech Toolbox can be downloaded free of charge from the internet at www.raytechusa.com or www.raytech.ch

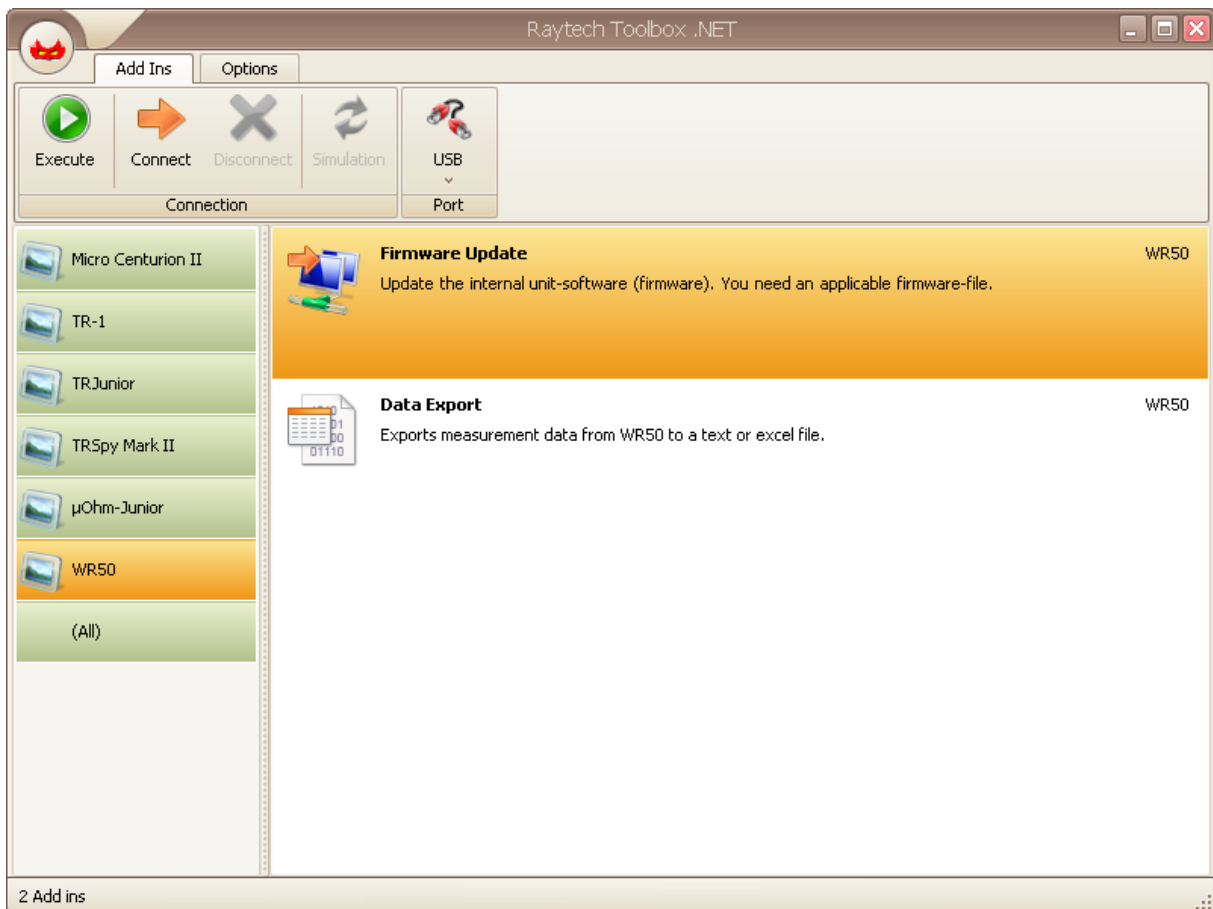



10.3 TR-Mark III 250V Communication Port



NOTE

⇒ TR-Mark III 250V communication interface is designed to work properly with the same hardware and command set as TR Spy Mark II. Commands not used on Mk-III will return 'ok' as the Answer.

10.3.1 Hardware Protocol

- 9 pole D-Sub
- Pin 2 TXD Data TRSpy to Computer
- Pin 3 RXD Data Computer to TRSpy
- Pin 7 GND
- +/- 12 V Signals

Protocol: 19200 Baud, 8 Bit, 1 Stop bit, no parity

10.3.2 Software Protocol



NOTE

⇒ Required firmware version 3.0.28.9 and later. Do not use former Versions for Remote Control. Call us for updates.

10.3.2.1 Switch to Remote

The Device is switched to REMOTE by:

- Command "RM"
- Every command which is executing a measurement (MA,MB,MC,MF)

10.3.2.2 Switch to Local

With Command SL (Set to Local) or with the Local Button on the display. This button will be the only object on screen until it is pressed.

10.3.2.3 Syntax of Commands

„cc [Data1[;Data]..]CR

cc = 2 ASCII Character for the Command

‘;’ (semicolon or space) Separator for multouchle Data fields

Numeric Format of Numbers: float (C - Language), “.” as decimal point

Format of Strings: all ASCII Characters from 0x20 to 0x7f

Terminator: „CR“ (= 0x0D) or LF (0x0A)

Answers without data: *0 ok ok *1 unknSyntax Error

Answers with data:

xx,Message1[,Message2;[Message3]..]“,CR

xx Type of answer (the command itself)

10.4 TR-Mark III 250V Remote Commands

Please contact your local representative or Raytech Switzerland for a complete and actual command set.



Appendix

Turns Ratio Meter 3 Phase Model TR-Mark III 250V



Raytech GmbH
Oberebenenstrasse 11
CH 5620 Bremgarten
Switzerland

Raytech USA, Inc.
118 S. 2nd Street
Perkasie, PA 18944
USA



Contents

A.A	Current Transformer Testing.....	50
A.A.A	Introduction.....	50
A.A.B	Usual Measurement.....	50
A.A.C	Low Impedance.....	51
A.A.D	Tapped Secondary.....	51
B	Test Reports.....	52
A.A	Internal printer.....	52
A.B	External printer.....	53
C	Firmware Update.....	54
D	Error Messages.....	55
E	Troubleshooting.....	56
F	Warranty Conditions.....	57



A.A Current Transformer Testing

A.A.A Introduction

Current transformers are, in effect, opposite wound voltage transformers. This basically means that the largest number of windings are on the “X” (low current) side of the current transformer.

The TR-Mark III 250V applies a voltage (from 1 to 250 VAC) from the “H” leads and measures back through the “X” leads. The “X” leads always must have a lower voltage than the “H” leads or an error will be displayed. Therefore, when testing Current transformers the “H” test leads are connected to the “X” terminal of the Current Transformer.



NOTE

⇒ For CT testing, “H” leads are connected to the “X” terminal of the Current Transformer.

A.A.B Usual Measurement

Connect the test leads as shown. For the highest accuracy, create a new transformer and select CT. Use 10V to start. Use 40V test voltage for very big ratios only. CT is selected for Current Transformers exclusively. This test set has a special Voltage / Current function built-in for Current Transformers. If an error is still present after using 10V, use test voltage 1V.

1. Connect a Current Transformer as following:

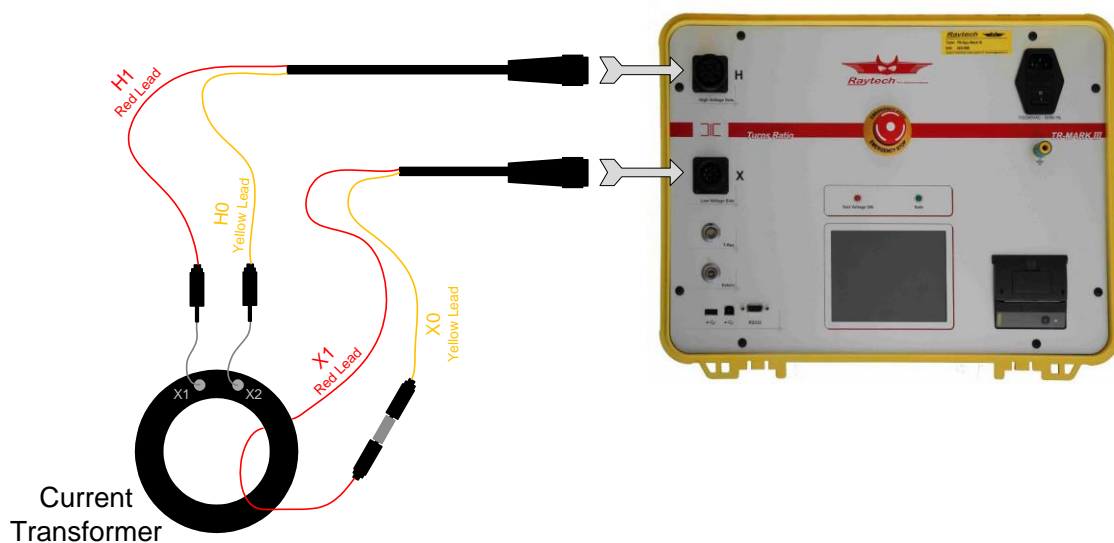



2: Select CT Testing, use 10 (normal),
40V (high ratio) or 1V (low impedance)

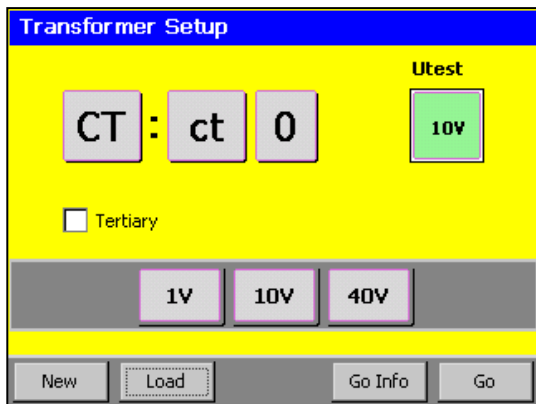

3: Touch Go A

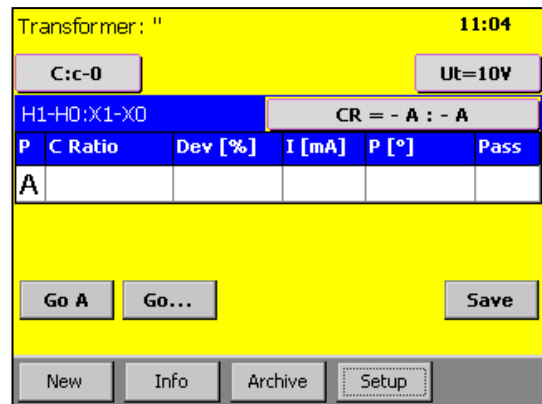

A.A.C Low Impedance

In certain cases, where the impedance (inductance) of the CT is so low that TR-Mark III 250V gets to its power limits, an "Overcurrent" Message will be displayed on the screen. It is then recommended to run the test with a lower test voltage.

A.A.C Info

Of course the ratio in the info field for CTs is defined by Amps / Amps. (Not Volts / Volts as it is used for voltage transformers. The rest of the 'Info' screen remains the same.

A.A.D CTs with Taps (Tapped Secondary)

Current transformers with multiple secondary taps are tested similar to single secondary taps. After each specific ratio is tested the H1 (or H0) lead can be moved to the next position and that ratio can then be tested.

In addition to the previous test the secondary of the CT can be tested like an auto transformer.



A Test Reports

Test Reports are printed results of TR-Mark III 250V. The following two chapters show test reports.

Please see chapter '8.1.2.3 'Tuns Ratio or Voltage Ratio, Print or Save' about how to print. To use the external instead of the internal printer, just connect a printer to USB port of TR-Mark III 250V.

A.A Internal Printer

Test				Report		
by Raytech TR Mark III						
Transformer						
VG :	D:yn-5					
Name :	Raytech					
Type :						
S/N :	21649					
Loc :	Bremgarten					
Rem :						
Std :	ANSI					
Measurement						
S/N :	304-112					
Date :	17.02.2011					
Time :	12:05					
Oper :						
2 : D:yn-5						
Utest: 100V						
P	S	Ph	TRatio	Dev[%]	I[mA]	P[°]
+1	0	A	71.475	0.01	0.4	+0.01 P
+1	0	B	71.495	0.04	1.1	+0.01 P
+1	0	C	71.475	0.01	0.3	+0.01 P
+2	0	A	69.355	-0.02	0.5	+0.01 P
+2	0	B	69.375	0.01	0.9	+0.01 P
+2	0	C	69.360	-0.01	0.4	+0.01 P
+3	0	A	67.250	-0.02	0.5	+0.00 P
+3	0	B	67.265	0.00	1.1	+0.01 P
+3	0	C	67.250	-0.02	0.4	+0.01 P



A.B External Printer



*** Test Report ***

Transformer Nameplate

Name: Raytech
 S/N: 21649
 Type:
 Manufacturer: Secheron
 Location: Bremgarten
 Remarks:
 Max Ratio Deviation: 0.5%
 Standard: ANSI

Configuration

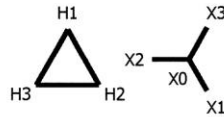

Measurement

Date: 17.02.2011 12:05
 S/N Device: 304-112

2: D:yn-5 A:H1-H3:X3-X0 B:H2-H1:X1-X0 C:H3-H2:X2-X0
 Utest: 100V

Tap Changer		Phase	Urated [kV]		Turn Ratio		Dev [%]	Itest [mA]	Angle [°]	Pass
Tap H	Tap X		U H	U X	Rated	Acutal				
+1		A	17.000	0.4120	71.470	71.475	0.01	0.4	+0.01	True
+1		B	17.000	0.4120	71.470	71.495	0.04	1.1	+0.01	True
+1		C	17.000	0.4120	71.470	71.475	0.01	0.3	+0.01	True
+2		A	16.500	0.4120	69.365	69.355	-0.02	0.5	+0.01	True
+2		B	16.500	0.4120	69.365	69.375	0.01	0.9	+0.01	True
+2		C	16.500	0.4120	69.365	69.360	-0.01	0.4	+0.01	True
+3		A	16.000	0.4120	67.265	67.250	-0.02	0.5	+0.00	True
+3		B	16.000	0.4120	67.265	67.265	0.00	1.1	+0.01	True
+3		C	16.000	0.4120	67.265	67.250	-0.02	0.4	+0.01	True



B Firmware Update

As Raytech GmbH always tries to increase comfort and quality of products, sometimes firmware updates may be available. Ask your local vendor, or visit our website www.raytechusa.com and have a look for new firmware releases.

Once you have downloaded your file containing a new version, copy it to the root directory³ of a USB memory stick. Then connect this stick to your TR-Mark III 250V. Usually the new firmware release will be detected and you will be asked if you like to install it.

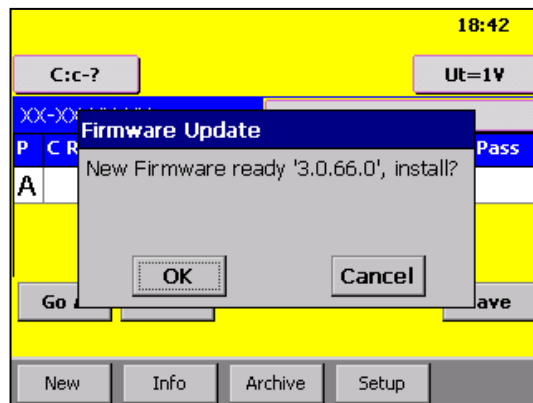

In some cases, for instance if you like to downgrade to an older version, you will have to start the installing process on your own. See the graphics bellow or see chapter '7.5.1.5 Update' for detailed information on how to do this.

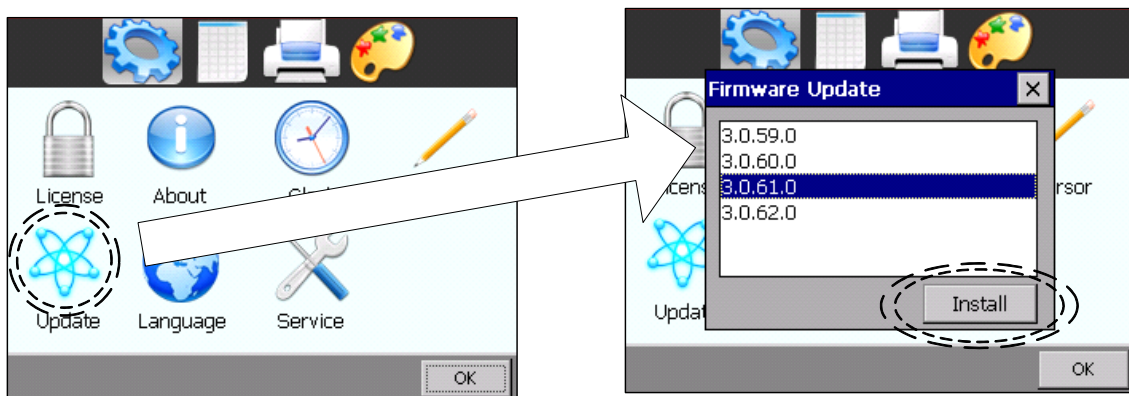

³ root means no subfolder, directly to the stick



C Error Messages

TR-Mark III 250V is designed to be trouble free, so you may not see many error messages. A few messages appear because of operation error. Let us have a look at those first.

<u>Message</u>	<u>Explanation</u>
No Test Leads:	TR-Mark III 250V may detect if there are no test leads connected, or if they are not connected to test object. This message may save time during measurements in the field.
Emergency Pressed:	No measurement can be started when the emergency switch is pressed. A running measurement will be cancelled immediately. Release the emergency switch, and this message will disappear.
Check Trafo Setup:	In many cases an incorrectly connected test object is detected by TR-Mark III 250V. Then this message appears.
T-Rex not found:	You will see this message, when trying to measure with a T-Rex (3P Configuration) which is not connected.
3P:3P only with Voltage Ext:	Another message that may appear when trying to start a T-Rex measurement without having it properly connected
Overcurrent:	As the message says, a high current is flowing on the H side. Check test settings and all connections.

Other messages may appear because of damage or malfunction of a component in the TR-Mark III 250V. If any of these messages appear on the screen, turn the TR-Mark III 250V off. Restart it after a few seconds and try again. If you still receive the same message, please contact our local representative or Raytech.

- Calibration failed
- Calib Warning
- Overload U, True
- ADC Quartz failed
- No Sync
- No Com
- H8Reset
- Comm Lost
- Relays,{0},{1}
- Voltage
- TRex
- Phase
- Tap Switch



D Troubleshooting

System does not display anything:

1. Check the display for any Initialization.
2. Check the fuse. The fuse is located in the Power switch / plug connector. Please see chapter '5.1 Front Panel Overview'. You will find it at position 1.

Touch Panel does not work:

Please connect any USB mouse to the USB port on the front panel. TR-Mark III 250V will display a cursor and everything can be done by mouse. Please see chapter '7.5.1.4' if cursor is not automatically displayed.

Measurement cannot be started:

Is the Emergency stop switch pushed in? Turn to release it.

USB Memory Stick does not work:

There are a few unsupported memory sticks available on the market. Please use another model and try again.



NOTE

⇒ TR-Mark III 250V is designed to be trouble free.
If problems or questions do arise please contact your nearest dealer or one of our service support groups:

	Switzerland:	USA:
Tel.	+41 56 648 6010	+ 267 404 2676
Fax.	+41 56 648 6011	+ 267 404 2685
Website:	www.raytech.ch	www.raytechusa.com
Email:	welcome@raytech.ch	Sales@RaytechUSA.com



E Warranty Conditions

RAYTECH USA, Inc. warrants to the original purchaser of any new TR-Mark III 250V, 3-Phase Transformer Turns that it will be free from defects in material and workmanship under normal use and service for a period of 5 years from the original date of shipment. This 5-year warranty is provided at no cost to the end user, for the products covered under this warranty if the products are returned on each calendar year from the original date of shipment, prepaid, to Raytech USA, for system evaluation. The obligation of RAYTECH USA, Inc. under this warranty is limited, in its exclusive option, to repair, replace, or issue credit for parts or materials which prove to be defective, and is subject to purchaser's compliance with the RAYTECH USA, Inc. warranty claim procedure as set forth within this manual.

This warranty covers only those parts and/or material deemed to be defective resulting from manufacturer's workmanship. The liability of RAYTECH USA, Inc. shall be limited to the repair, replacement, or issuance of credit for parts deemed defective within the meaning of this warranty. Costs for labor or other expenses that may have occurred incidental to the inspection, repair, replacement, or issuance of credit for such parts and/or materials shall be the sole responsibility of purchaser. This warranty shall not apply to any accessories, parts, or materials not manufactured or supplied by RAYTECH USA, Inc.

Equipment must be returned prepaid with a Return Material Authorization (RMA) to:

RAYTECH USA, Inc.
118 S. 2nd Street
Perkasie, PA 18944 USA
Tel. + 267 404 2676 Fax. + 267 404 2685
www.RaytechUSA.com

LIMITATION OF WARRANTY

The foregoing warranty shall not apply to defects resulting from improper and unauthorized modifications or misuse and abuse of the product, negligence, alteration, modification, faulty installation by the customer, customer's agents or employees. Attempted or actual dismantling, disassembling, service or repair by any person, firm, or corporation not specifically authorized in writing by RAYTECH USA, Inc.

Defects caused by or due to handling by carrier, or incurred during shipment, trans-shipment, or other move. Inadequate maintenance by the customer, second source supplied software or interfacing, operation outside the environmental limits, or improper site preparation. Exclusive remedies provided herein are the customer's sole and exclusive remedies. RAYTECH USA, Inc. shall not be liable for any damages resulting from the use of this equipment whether direct, indirect, special, incidental, or consequential damages, or whether based on contract, tort, or any other legal theory.

NO OTHER WARRANTY OR REMEDY IS EXPRESSED OR IMPLIED.