



INSTRUCTION MANUAL

ENGLISH



mini-ATOS

mini Automatic Transformer
Observation System

RAYTECH AG, OBEREBENESTRASSE 11, CH-5620 BREMGARTEN, SWITZERLAND

RAYTECH USA, INC. 118 S. 2ND ST. PERKASIE, PA 18944

Preliminary

Contents

1	Safety Precautions.....	6
1.1	Operators Qualifications	6
1.2	High Voltage Apparatus Accessibility During the Tests	6
1.3	Ground the Instrument	6
1.4	Before Applying Power	7
1.5	Keep Away from Live Circuits	7
1.6	Do Not Operate in An Explosive Atmosphere	7
1.7	Do Not Substitute Parts or Modify Instrument	7
1.8	Do Not Operate in A Condensing Humidity or Under Rain	7
1.9	Always Keep Distance from the Test Object During the Tests	7
2	Unpacking.....	9
3	Introduction.....	10
4	Calculation and Measurement Methods.....	11
4.1	Turns Ratio Measurement.....	11
4.1.1	Principle.....	11
4.1.2	Voltage Ratio and Turns Ratio	11
4.1.3	Relative Error.....	13
4.2	DC Resistance Test.....	14
4.2.1	Principle.....	14
4.2.2	Temperature Correction.....	15
4.2.3	Resistance Deviation	16
4.3	Demagnetization.....	17
4.3.1	Raytech SPP Demagnetization Method	18
4.3.2	Three-Phase Transformer Demagnetization	18
4.4	Magnetic Balance	19
4.5	Short Circuit Impedance	20
4.5.1	Principle.....	20
4.5.2	Short Circuit Jumpers	21
4.5.3	Temperature correction.....	21
4.5.4	Short circuit impedance deviation	21
5	Measurement Setup.....	22
5.1	Connecting Test Cables to Transformer Terminals	22
6	Operation Elements	24
6.1	Mains Input, Fuse and Mains Switch.....	24

6.2	Ethernet Interface	24
6.3	USB Interfaces (1x Host, 2x Device).....	24
6.4	Safety Indicators	24
6.5	Protective Earth Terminal	25
6.6	Emergency Stop	25
6.7	Display and Touch Panel	25
6.8	Low Voltage Side Receptacles	25
6.9	High Voltage Side Receptacles.....	25
6.10	Thermal Printer	25
6.11	Tap Control.....	25
6.12	External	25
6.13	Current Clamp Receptacle.....	25
6.14	Temperature Channels Receptacles.....	25
7	User Interface	26
7.1	Home Screen.....	26
7.2	Archive	28
7.3	Templates.....	31
7.4	Settings.....	33
7.4.1	Date and Time	33
7.4.2	Regional	33
7.4.3	Naming Scheme	34
7.4.4	Networking.....	34
7.4.5	Remote Access.....	35
7.4.6	Maintenance	36
7.4.7	License	37
7.4.8	System Info.....	37
8	Test Objects.....	38
8.1	Power Transformer	38
8.1.1	Windings.....	39
8.1.2	Winding Configuration Autodetect.....	42
8.1.3	Nameplate	43
8.1.4	General.....	44
8.1.5	Tap Changer.....	46
8.1.6	Electrical Values	47
8.2	Auto Transformer.....	51
9	Inspection and Test Plan.....	52
10	Measurements	55

10.1	Turns Ratio	55
10.1.1	Table view modes.....	57
10.1.2	Turns ratio settings	58
10.1.3	Turns Ratio Results View.....	59
10.2	Winding Resistance	61
10.2.1	Dual Supply Winding Resistance	64
10.2.2	Winding Resistance Settings	65
10.2.3	Winding Resistance Result View	68
10.2.4	Auto Transformer Winding Resistance.....	69
10.3	Winding Resistance Interval.....	72
10.3.1	Winding Resistance Interval Settings.....	74
10.3.2	Winding Resistance Interval Result View.....	76
10.4	Demagnetization.....	77
10.4.1	Demagnetization Settings	79
10.5	Magnetic Balance	80
10.5.1	Magnetic Balance Settings	82
10.5.2	Magnetic Balance Result View.....	83
10.6	Short Circuit Impedance	84
10.6.1	Short Circuit Impedance Settings.....	86
11	Go Taps	88
12	Remote Access Instruction.....	90
13	Interfaces	92
13.1	USB.....	92
13.2	Ethernet.....	92
13.3	External (4pins version)	93
13.4	External (6pins version)	94
13.5	Tap Control.....	95
14	Technical Specifications.....	96
14.1	General.....	96
14.2	Accuracies	97
14.2.1	Turns Ratio Measurement	97
14.2.2	Resistance Measurements	98
14.2.3	Temperature Measurement.....	98
14.3	Standards and Approvals.....	99
A	Warranty Conditions	102
A.1	Limitation of Warranty.....	102
A.2	Arbitration	103

B	Maintenance	104
B.1	Instrument Cleaning Instruction	104
B.2	How to Insert Paper into Thermal Printer	104
B.3	Thermal Printer Cleaning instruction	105
C	Index.....	106
D	Contacts	108

1 Safety Precautions

The following safety precautions must be observed during all phases of operation, service and repair of this instrument. By purchasing this equipment, the purchaser assumes all liability for the operation and use of this equipment. The intended use of the instrument, its design and manufacture, is to be conducted within the precautions or other specific warnings located within this manual. Failure to comply with these precautions and other specific warnings violates the safety standards of design, manufacture, and intended use. Raytech assumes no liability for the operation and use of this equipment.

1.1 Operators Qualifications

Only qualified, knowledgeable persons should be permitted to or attempt to operate this test equipment. All testing personnel should fully familiarize themselves with the correct application and operation of this and all test equipment before operation.

The measurements should never perform by only one operator without the presence of other personnel or supervisors. Someone else other than the main operator must be aware and easily accessible to help in case of an emergency.

1.2 High Voltage Apparatus Accessibility During the Tests

Persons directly and indirectly engaged in the operation of this test equipment should keep clear of all high voltage apparatus while conducting tests and measurements. A barrier band must always use so the test object under the test is not accessible to any person during the test.



WARNING!

Never connect the instrument to an energized transformer!

1.3 Ground the Instrument

The power cord supplied with the equipment must be connected to an electrical receptacle with an electrically grounded terminal (earthed ground). To minimize shock hazards, the ground terminal on the instrument must be properly connected to the earth point. In many cases, the quality of the safety ground terminal provided by the power cord does not fulfil the safety requirements.



WARNING!

Non-grounded instruments are dangerous and may cause damage to personnel and to the instrument.

1.4 Before Applying Power

Read this manual carefully before operating the system. The instrument is line operated. The system is designed to be used with either 110VAC or 230VAC 50/60 Hz. The system performs a self-check each time it is powered on.

1.5 Keep Away from Live Circuits

Operating personnel must not remove instrument covers. Component replacement and internal repairs must be made by qualified service personnel. Do not replace components or service this instrument with the power cable connected. To avoid injuries, always discharge circuits, disconnect power and remove external voltage sources before touching components.

1.6 Do Not Operate in An Explosive Atmosphere

Do not operate the instrument in the presence of flammable gases or fumes.

1.7 Do Not Substitute Parts or Modify Instrument

Because of the danger of introducing additional hazards, do not install substitute parts or perform any unauthorized modification to the instrument. Return the instrument to a Raytech service department for service to ensure proper operation and that safety features are maintained.

Instruments, which appear damaged or defective, should be made inoperative and secured against unintended operation until they can be repaired by qualified service personnel.

1.8 Do Not Operate in A Condensing Humidity or Under Rain

Operating the instrument in condensing humidity or under the rain can introduce an electric shock hazard for the user and also can damage the instrument. This instrument is not supposed to be installed permanently outdoor.

1.9 Always Keep Distance from the Test Object During the Tests

During performing the tests, there may be a hazardous voltage at the terminals of the test object. Always keep a distance of a minimum of 1.5m from the test object. The unsafe area must be specified and restricted with barrier tapes or ropes like Figure 1. Enter the area only when not testing and when the instrument shows that there is no output voltage which is specified when the green light indicator on the front panel is on.

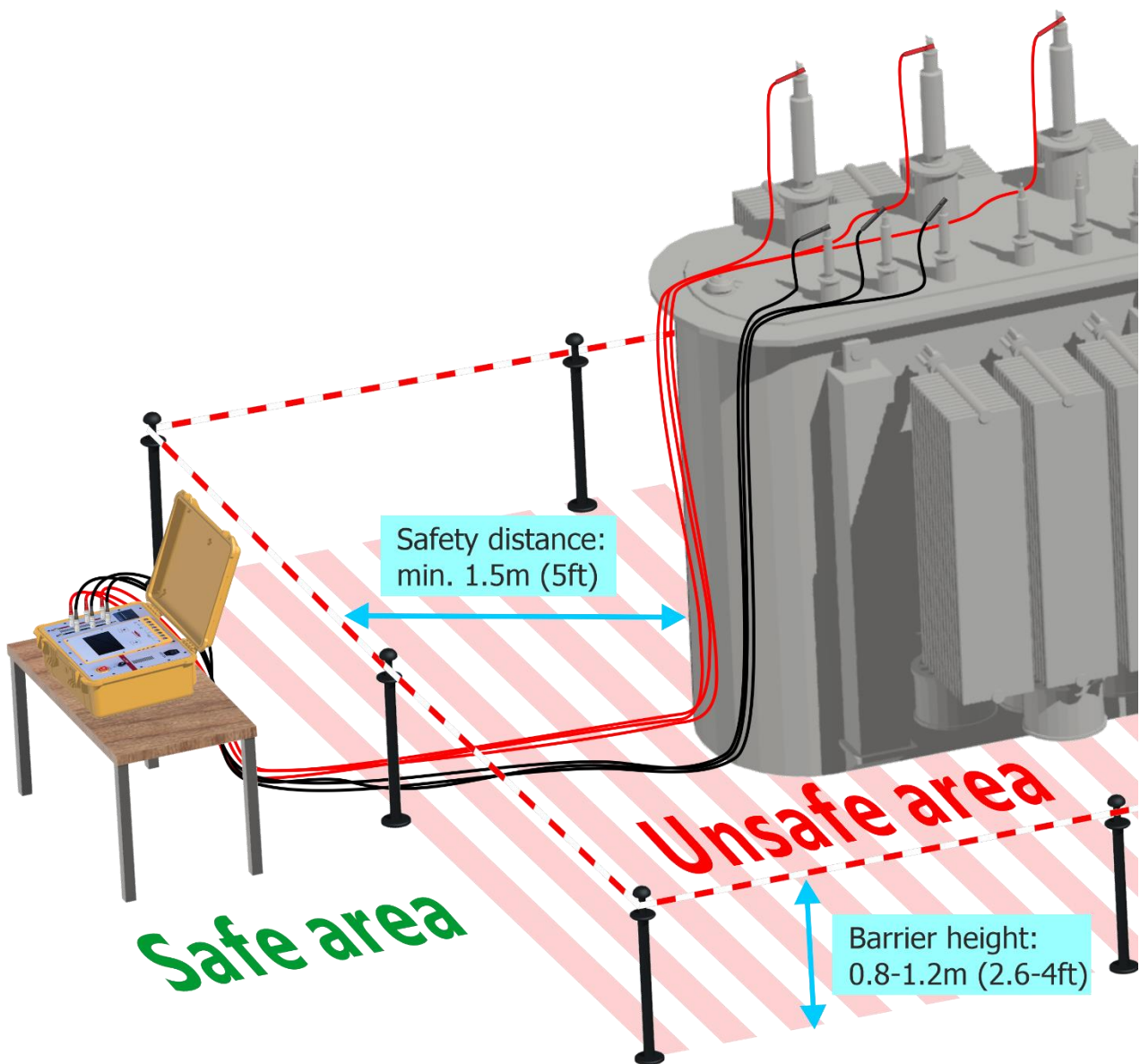

Figure 1: The unsafe area must be specified and restricted with barrier tapes or ropes



WARNING!

Always keep distance from the test object during the tests and the unsafe area must be specified and restricted with barrier tapes or ropes

2 Unpacking



The Instrument



Cable Bags



Measuring Cables H (H0-H3)



Measuring Cables X (X0-X3)



Safety Ground Cable



Power Cord



Spare Paper rolls & Fuses



USB Memory Stick



Instruction Manual (Pre.)

3 Introduction

The Raytech precision mini–Automatic Transformer Observation System (mini-ATOS) is a professional multifunctional power transformer and substation diagnosing test instrument developed by Raytech engineers. It is designed for a high degree of accuracy and ease of use.

This compact and intelligent instrument can perform many routines and advanced tests such as Winding Resistance (WR), Dynamic Resistance Measurement (DRM), Turns Ratio (TR), Frequency Response of Stray Losses (FRSL), Magnetic Balance, and other diagnostic parameters. With the built-in fully automatic multiplexer, only a one-time connection is required for nearly all functions which saves a considerable amount of time. The portable, rugged case is perfect for use anywhere onsite or in a laboratory. It is specially designed for fast and easy measurements with the well-known high precision and quality of all Raytech instruments.



INFO:

The mini-ATOS field case is a waterproof design (IP67). A pressure regulator activates when the case is opened to compensate for atmospheric pressure changes.

4 Calculation and Measurement Methods

4.1 Turns Ratio Measurement

4.1.1 Principle

The transformer turns ratio test is used for measuring the ratio of turns of wires of the two sets of windings e.g., the primary side and the secondary side of a transformer. The turns ratio test does not tell exactly how many turns of wire are in each coil, but rather, it measures and displays the ratio of the number of turns of two coils.

This is a useful test to check for shorted turns and also to find probable incorrect settings of tap changers during manufacturing or repairing.

The mini-ATOS performs the turns ratio by applying voltage on the high voltage side of each phase and measuring the applied voltage and transformed voltage. Figure 2 represents the very simple schematic of the measuring circuit.

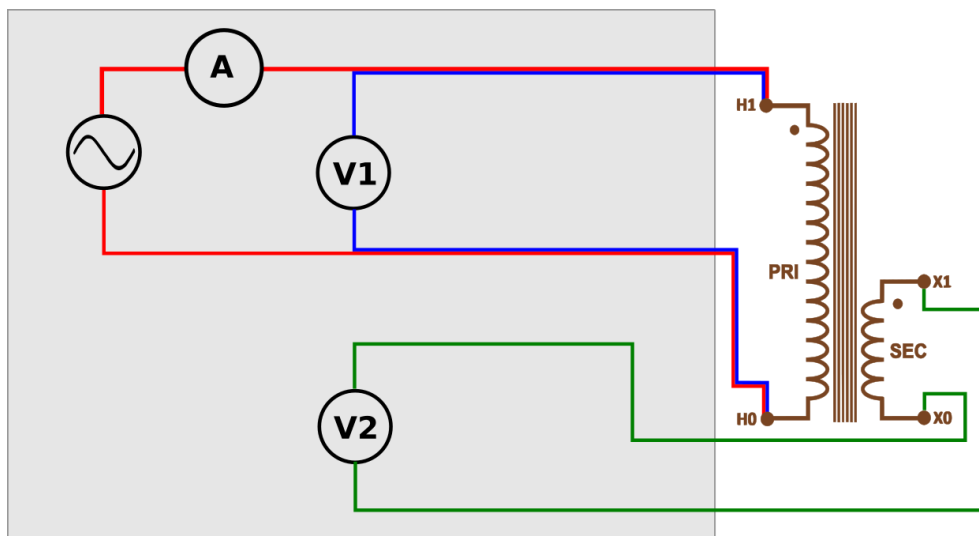

Figure 2: Very simple schematic of mini-ATOS turns ratio measuring circuit

The excitation current is also measured during the turns ratio test. The value of the excitation current has a direct relation to the test voltages. A higher test voltage leads to a higher excitation current. Additionally, the phase angle between the applied voltage and the transformed voltage is also measured and is included in the results.

4.1.2 Voltage Ratio and Turns Ratio

It is important to understand the differences between transformer voltage ratio and transformer turns ratio. The voltage ratio is the ratio of rated voltages of two windings but the turns ratio is exactly the ratio of the number of turns of two sets of windings. For a single-phase Transformer, the Turns Ratio is the same as the Voltage Ratio, however for a three-phase transformer they may be different.

As an example, consider a single-phase transformer schematic with a primary side and a secondary side. The primary side nominal voltage which is written on the nameplate is 6900V and from the manufacturing data, we know it consists of 15000 turns. And secondary side nominal

voltage written on the nameplate is 230V which consists of 500 turns from manufacturing data. The following equations are valid:

$$\text{Voltage Ratio} = \frac{\text{Rated Voltage Primary}}{\text{Rated Voltage Secondary}} = \frac{6900}{230} = 30$$

$$\text{Turns Ratio} = \frac{\text{Primary Number of Turns}}{\text{Secondary Number of turns}} = \frac{15000}{500} = 30$$

$$\text{Voltage Ratio} = \text{Turns Ratio} = 30$$

With three-phase transformers of different configurations, turns ratio and voltage ratio can be different.

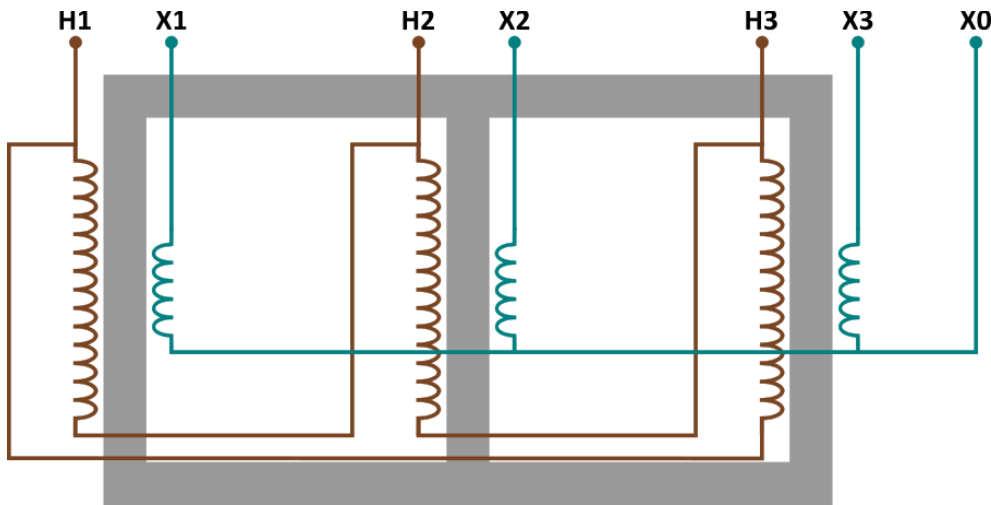

Figure 3: Three-phase transformer schematic with Dyn11 vector group

For example, Figure 3 shows a three-phase transformer schematic with a delta connection on the primary and star connection on the secondary side. 120000V and 20000V are written as primary and secondary rated voltages respectively on the nameplate. The rated values are always line-line voltages and the voltage ratio can simply calculate as follow:

$$\text{Voltage Ratio} = \frac{\text{Rated Voltage Primary}}{\text{Rated Voltage Secondary}} = \frac{120000}{20000} = 6$$

Turns ratio is different from the voltage ratio because the low voltage side connection is star and line-line rated voltage is different from the phase voltage. So, a factor of $\sqrt{3}$ is required as follow to calculated the nominal turns ratio:

$$\text{Turns Ratio} = \text{Voltage Ratio} \times \sqrt{3} = 6 \times \sqrt{3} = 10.3923$$

When we know the number of turns from the manufacturing data, the turns ratio can be calculated directly. Consider that for the current example the number of turns is 93531 and 9000 for each primary and secondary winding respectively. The following equations are valid:

$$\text{Turns Ratio} = \frac{\text{Primary Number of Turns}}{\text{Secondary Number of turns}} = \frac{93531}{9000} = 10.3923$$

$$\text{Voltage Ratio} = \frac{\text{Turns Ratio}}{\sqrt{3}} = \frac{10.3923}{\sqrt{3}} = 6$$

4.1.3 Relative Error

Turns ratio error can be calculated by comparison of the measured value and the reference rated value using the following formula:

$$\text{Err. [\%]} = \frac{|TR_{meas.} - TR_{rated}|}{TR_{rated}} \times 100\%$$

The calculated error can be compared with a limit value. Generally, there are limit values for the turns ratio relative error. A typical limit value according to IEEE C57.12.00-2010 is 0.5%. This limit value can be used to judge if the test is passed or failed.

4.2 DC Resistance Test

4.2.1 Principle

The winding DC resistance test is one of the most important tests. Many power transformer faults such as shorted turns, tap changer problems and loose connections can be detected.

Figure 4 represents the summarized winding resistance measurement circuit of the mini-ATOS. It utilizes the 4-wire measuring technique for each measurement. 2 wires to inject current and 2 wires to measure voltage. The test measuring cables and clamps are Kelvin type which means that the user does not have to hook up separately additional cables to the transformer for measuring.

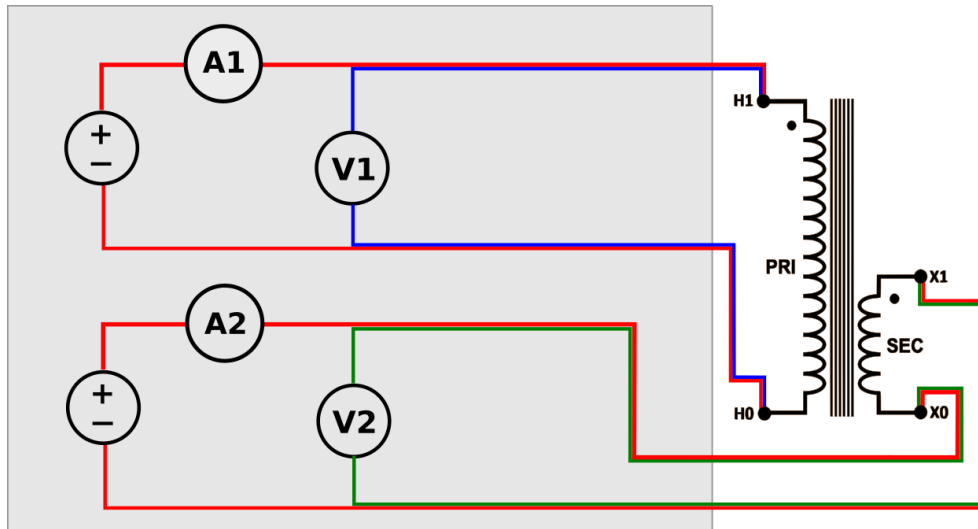

Figure 4: Summarized schematic of mini-ATOS winding resistance measuring circuit

The mini-ATOS has two power supplies with the same output power which can be used to measure both high and low voltage side winding simultaneously.

The maximum output voltage and current of each power supply are different to provide optimal output for each side. One power supply has more output voltage which is suitable for the high voltage side with a bigger resistance and the other one has more output current which is suitable for the low voltage side with a smaller resistance.

During the measurement, because of the high inductivity, the core and winding must be charged and only after charging, stable and accurate measuring is possible. The following equation represents the relation between the current injected into the winding, $I(t)$, and the voltage drop value, $U(t)$, across the winding. R is the winding resistance value that is aimed to be measured and L is the equivalent value of the inductivity.

$$U(t) = R \times I(t) + L \times \frac{dI(t)}{dt}$$

The voltage drop value consists of two parts; the first part is the voltage drop because of the resistance, and the second part is the voltage drop because of the inductivity. After charging, the second part tends to zero and then the Resistance value can be calculated:

$$\frac{dI(t)}{dt} \rightarrow 0 \Rightarrow U(t) = R \times I(t) \Rightarrow R = \frac{U}{I}$$

The mini-ATOS winding resistance circuit is also equipped with heavy-duty discharge circuits that are very unique in design to dissipate the stored energy in the transformer windings.

4.2.2 Temperature Correction

The DC resistance measured values can be corrected to the desired reference values by employing the following equation based on IEEE C57.12.90:

$$R_s = R_m \frac{T_s + T_k}{T_m + T_k}$$

Where:

$R_s[\Omega]$ = Corrected resistance

$R_m[\Omega]$ = Measured resistance

$T_s[^\circ\text{C}]$ = Desired reference temperature

$T_m[^\circ\text{C}]$ = Actual temperature at the time of resistance measurement

$T_k[^\circ\text{C}]$ = Correction temperature

Correction values for copper and aluminum are:

Table 1: Cu and Alu temperature correction values

Material	$T_k[^\circ\text{C}]$
Copper	234.5
Aluminum	225
Alloyed aluminum	Can be up to 230

The other form of temperature correction formula is:

$$R_m = R_s(1 + \alpha(T_m - T_s))$$

Where:

α = Coefficient factor of resistivity at desired reference temperature

T_k and α have the following relationship:

$$T_k = \frac{1}{\alpha} - T_s = \frac{1}{\alpha(@20^\circ\text{C})} - 20$$

For example, by considering that the value of α for copper is 0.00393 at 20°C, T_k is:

$$T_k = \frac{1}{0.00393(@20^\circ\text{C})} - 20 \cong 234.5$$

4.2.3 Resistance Deviation

For a 3-phase test object, the DC resistance values of each phase are supposed to be almost the same. Hence, it is possible to measure a deviation value from the average value for each phase as follows:

$$R_{avg}[\Omega] = \frac{R_A + R_B + R_C}{3}$$

$$R_{dev,A}[\%] = \frac{R_A - R_{avg}}{R_{avg}} \times 100$$

$$R_{dev,B}[\%] = \frac{R_B - R_{avg}}{R_{avg}} \times 100$$

$$R_{dev,C}[\%] = \frac{R_C - R_{avg}}{R_{avg}} \times 100$$

The calculated deviations can be compared to a maximum deviation limit value to find out if the result is passed or failed. There is a limit in IEEE C57.12.152-2013, which is 2%. However other values are also possible with agreements.

Please note that if the temperature of phases is not the same during the resistance measurements, the deviation values may be higher. In this case, it is better to calculate the deviation values of the temperature-corrected resistances.

4.3 Demagnetization

After transformer shutdown or a measurement with a direct current, there is always residual magnetism or remanence in the transformer magnetic core. There are various reasons that this remanence should be removed. One reason is that energizing a transformer with remanence can cause a much higher inrush current and this may cause deformation of the winding. The other reason is that the remanence will affect the results of some tests such as SFRA, magnetic balance and excitation current, which may lead to a wrong diagnosis.

The mini-ATOS includes a very efficient, fast and modern demagnetization feature. During the demagnetization, all important parameters are measured, calculated and monitored continuously and each cycle of the demagnetizing is adjusted and performed according to the previous cycles.

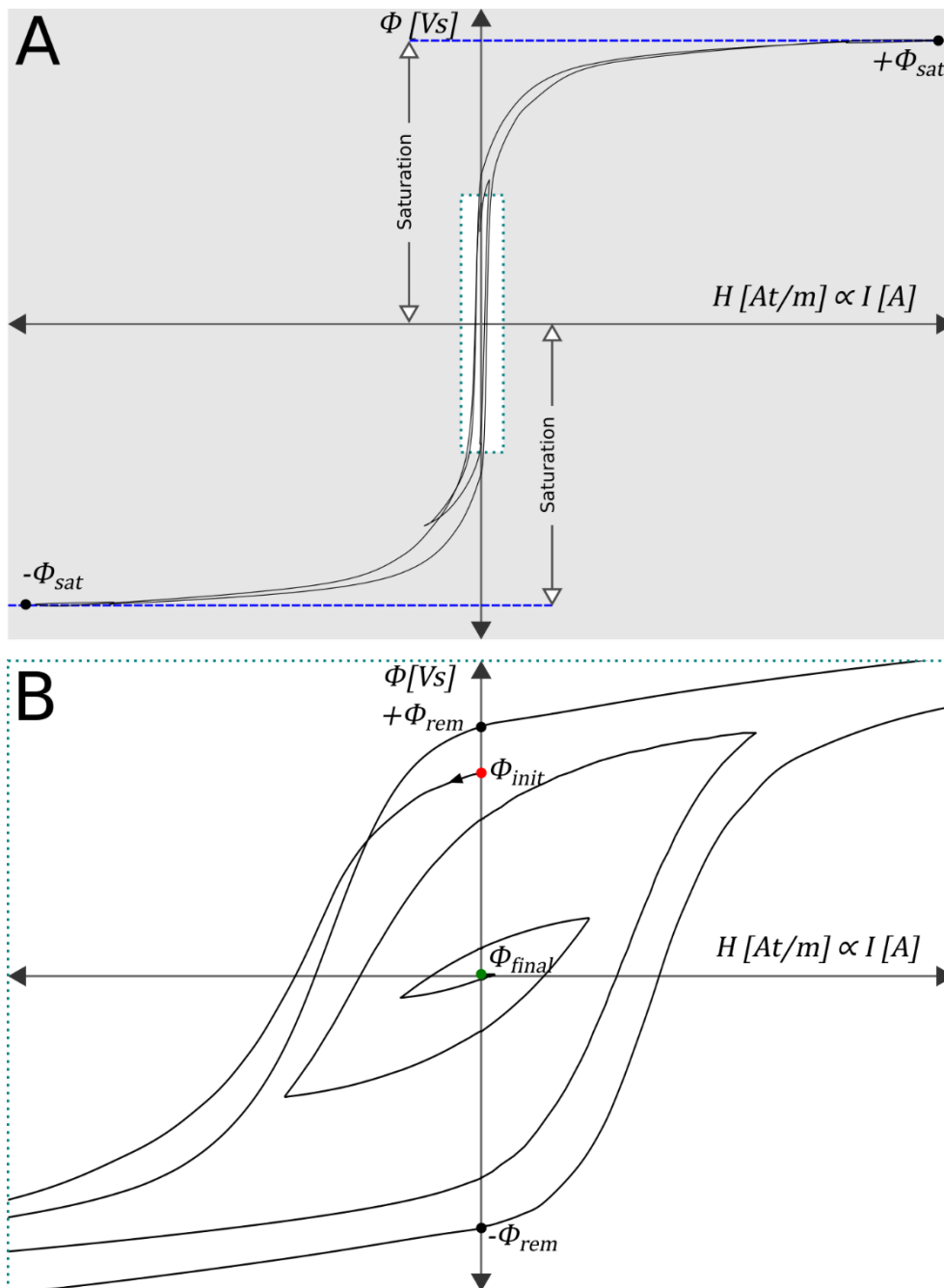

Figure 5: A) A real example of a demagnetization with mini-ATOS. B) Closer look at the same curve in A.

Figure 5-A shows an actual example of a hysteresis curve during demagnetization which is performed using the mini-ATOS. Figure 5-B is a closer look at the same curve. The depicted parameters are described below:

- $\Phi[V \cdot s]$: Magnetic flux with the unit of volt-seconds or weber. It will be measured as integral of the inductive part voltage over time. The value of the Vs is related directly to the magnetic flux density with the unit of tesla, by considering that the cross-section area of the transformer magnetic core is a constant value:

$$T = \frac{V \cdot s}{m^2} ; m^2 = constant \Rightarrow T \propto V \cdot s$$

- $H(At/m)$: Magnetic field strength with the unit of ampere-turn/meter. The number of the turns and length of the magnetic path is usually unknown but since they are constant values, the magnetic field strength is in direct relation to the injected current to the winding which can be measured directly:

$$\frac{At}{m} ; t = constant, m = constant \Rightarrow \frac{At}{m} \propto A$$

- $\pm\Phi_{sat}$: Maximum positive or negative flux at saturation point
- Φ_{init} : The initial value of the residual magnetism flux or remanence flux before demagnetization
- Φ_{final} : The final value of the remanence flux after performing the demagnetization
- $\pm\Phi_{rem}$: Maximum positive or negative remanence flux remains in the magnetic core which is normally happened after saturation.

4.3.1 Raytech SPP Demagnetization Method

To achieve a very small residual magnetism, the mini-ATOS use a special method to perform the final cycles of the demagnetization, called **SPP**, **Smart Pattern Predictor**, which is based on pattern recognition. This is very useful when special measurements like SFRA are desired to perform.

This method recognizes the properties and shape of the demagnetization of previous cycles to achieve a very small remanence, the shape and properties of the final cycles are predicted and then the final cycles will be performed in a way to achieve the best and the smallest possible residual magnetism state.

4.3.2 Three-Phase Transformer Demagnetization

For a core-type three-phase transformer with three limbs, the demagnetization is usually performed from the middle phase. Many times, it is enough to achieve a safe residual magnetism state to connect the transformer to the power grid without the risk of high inrush current. However, it is not always like this. Sometimes the demagnetization should be performed from all three phases. The following items can be a reason to consider a three-phase demagnetization:

- When the core consists of 4 limbs or 5 limbs
- When the transformer is a shell-type
- When the aim is to achieve a very small residual magnetism to perform special tests like SFRA

The mini-ATOS can use the advantage of the automatic multiplexer to perform demagnetization from each phase automatically and without changing the connection setup.

4.4 Magnetic Balance

Raytech mini-ATOS performs the magnetic balance test by applying AC voltage on each winding of the three-phase transformer from the high voltage side and measuring induced voltage into other windings on the same side. The applied voltage produces magnetic flux in the core which is distributed to other parts of the core and induces a voltage into other windings. Any problem or fault in the magnetic core may change the distribution of flux.

For a healthy core-type transformer with a demagnetized 3 limb core, the magnetic balance test results should be in the form of Table 2:

Table 2: Typical magnetic balance pattern of a core-type transformer with 3 limbs

Phase	→ A	→ B	→ C
A	$V_{A \rightarrow A} = 100\%$	$V_{A \rightarrow B} \cong M\%$	$V_{A \rightarrow C} = N\%$
B	$V_{B \rightarrow A} \cong 50\%$	$V_{B \rightarrow B} = 100\%$	$V_{B \rightarrow C} \cong 50\%$
C	$V_{C \rightarrow A} \cong N\%$	$V_{C \rightarrow B} \cong M\%$	$V_{C \rightarrow C} = 100\%$

The sum of M and N should be almost 100% and it is supposed to M be greater than N :

$$M + N \cong 100, \quad M > N$$

The index TCI [%], Transformer Core Imbalance, introduced by Raytech for easy diagnosing of magnetic balance test results. It is calculated using the following formula:

$$\text{Core Imbalance} [\%] = 100 \times \left(\frac{|V_{A \rightarrow C} - V_{C \rightarrow A}|}{V_{A \rightarrow C} + V_{C \rightarrow A}} + \frac{|V_{B \rightarrow A} - V_{B \rightarrow C}|}{V_{B \rightarrow A} + V_{B \rightarrow C}} + \frac{|V_{A \rightarrow B} - V_{C \rightarrow B}|}{V_{A \rightarrow B} + V_{C \rightarrow B}} \right) \times \frac{1}{3}$$

Please note that when the core is not fully demagnetized, the TCI value may be high. For a correct magnetic balance test, it is highly recommended to always demagnetize the core beforehand. On the other hand, by performing the magnetic balance test, it is possible to find out if the transformer core is demagnetized or not.

4.5 Short Circuit Impedance

4.5.1 Principle

The short circuit impedance/ leakage reactance test is helpful to detect the windings mechanical deformations. It is performed by applying AC voltage on each phase on the primary side, while the other side circuit is shorted. The performed voltage, injecting current and the phase difference will be measured and from the measured values, the short circuit impedance, leakage reactance and ac resistance will be calculated:

$$Z_{m_A} [\Omega] = \frac{U_A}{I_A} \quad Z_{m_B} [\Omega] = \frac{U_B}{I_B} \quad Z_{m_C} [\Omega] = \frac{U_C}{I_C}$$

$$Z_{m_A} = (R_{m_A} + iX_{m_A}) [\Omega]$$

$$Z_{m_B} = (R_{m_B} + iX_{m_B}) [\Omega]$$

$$Z_{m_C} = (R_{m_C} + iX_{m_C}) [\Omega]$$

Where:

U_A, U_B, U_C = Applied test voltages for each phase

I_A, I_B, I_C = Test currents for each phase

$Z_{m_A}, Z_{m_B}, Z_{m_C}$ = Measured short circuit impedance of each phase

$R_{m_A}, R_{m_B}, R_{m_C}$ = The AC resistance part for each phase

$X_{m_A}, X_{m_B}, X_{m_C}$ = The leakage reactance part for each phase

The equivalent there phases short circuit impedance, AC resistance and leakage reactance will be calculated as follows:

$$Z_{sc} [\Omega] = \frac{1}{6} (Z_{m_A} + Z_{m_B} + Z_{m_C})$$

$$Z_{sc} = (R_{sc} + iX_{sc}) [\Omega]$$

With the Nominal voltage and base power, it is also possible to calculate the values in percents:

$$Z_{base} = \frac{U_n^2}{S_{base}}$$

$$Z_{sc} [\%] = \frac{Z_{sc} [\Omega]}{Z_{base}} \times 100\%$$

$$R_{sc} [\%] = \frac{R_{sc} [\Omega]}{Z_{base}} \times 100\%$$

$$X_{sc} [\%] = \frac{X_{sc} [\Omega]}{Z_{base}} \times 100\%$$

4.5.2 Short Circuit Jumpers

The mini-ATOS, short circuits the other side windings automatically, however, it is strongly recommended to short manually by using the low resistance jumpers. The reason is that the mini-ATOS test cable's resistance is too big in comparison to the resistance of the windings and hence has an effect on the measurement. The special jumper cables for this aim can be ordered as optional accessories from Raytech.

4.5.3 Temperature correction

The winding temperature has effect on the ac resistance value and so it can be corrected to a reference temperature. The method is exactly like the DC resistance temperature correction. For more information, please refer to chapter 4.2.2.

The winding temperature has no effect on the leakage reactance, however it has effect on the short circuit impedance, because the ac resistance is the real part of the short circuit impedance.

4.5.4 Short circuit impedance deviation

For a 3-phase test object, the short circuit impedance values of each phase are supposed to be almost the same. Hence, it is possible to measure a deviation value from the average value for each phase as follows:

$$Z_{avg}[\Omega] = \frac{Z_{m_A} + Z_{m_B} + Z_{m_C}}{3}$$
$$Z_{dev,A}[\%] = \frac{Z_{m_A} - Z_{avg}}{Z_{avg}} \times 100\%$$
$$Z_{dev,B}[\%] = \frac{Z_{m_B} - Z_{avg}}{Z_{avg}} \times 100\%$$
$$Z_{dev,C}[\%] = \frac{Z_{m_C} - Z_{avg}}{Z_{avg}} \times 100\%$$

The calculated deviations can be compared to a maximum deviation limit value to find out if the result is passed or failed.

Please note that if the temperature of phases is not the same during the short circuit impedance measurements, the deviation values may be higher. In this case, it is better to calculate the deviation values of the temperature-corrected values.

5 Measurement Setup

5.1 Connecting Test Cables to Transformer Terminals

This chapter explains the measurement setup of power transformers and auto transformers.

Connect the mini-ATOS to the test object terminals with the labelled test leads by using the connection guides according to Table 3 or Table 4.

When you want to perform a measurement in which tertiary winding is involved (e.g., Turns ratio between primary and tertiary), you have to connect the mini-ATOS X Cables to the tertiary side.

Because of safety, it is not recommended to perform tests between secondary and tertiary. The voltage may transform to a very dangerous level at the primary side during the measurements.

Check the nameplate information of the transformer. If the nameplate is missing it is still possible to test the transformer by a trial-and-error method. The mini-ATOS test set is designed to detect errors in transformer hook-ups. Contact Raytech Service & Support department if you need assistance.



WARNING!

It is not recommended to test between secondary and tertiary sides!
The voltage may transform to a very dangerous level at the primary side during the measurements.

Table 3: Test cables connection guide for a single-phase power transformer and auto transformer

Voltage Level	mini-ATOS Test Cable Label	Transformer Naming Scheme			
		IEEE	IEC	ABCN	
Primary	H1	H1	1.1 ¹	U1	A1
	H2	H2	1.2	U2	A2
Secondary	X1	X1	2.1	u1	a1
	X2	X2	2.2	u2	a2
Tertiary	X1	Y1	3.1	3U1	3A1
	X2	Y2	3.2	3U2	3A2

¹ Dot can be a letter. For example: 1U1

Table 4: Test cables connection guide for a three-phase power transformer and auto transformer

Voltage Level	mini-ATOS Test Cable Label	Transformer Naming Scheme			
		IEEE	IEC	ABCN	
Primary	H1	H1	1U	U	A
	H2	H2	1V	V	B
	H3	H3	1W	W	C
	H0	H0	1N	N	N
Secondary	X1	X1	2U	u	a
	X2	X2	2V	v	b
	X3	X3	2W	w	c
	X0	X0	2N	n	n
Tertiary	X1	Y1	3U	3U	3A
	X2	Y2	3V	3V	3B
	X3	Y3	3W	3W	3C
	X0	Y0	3N	3N	3N

6 Operation Elements

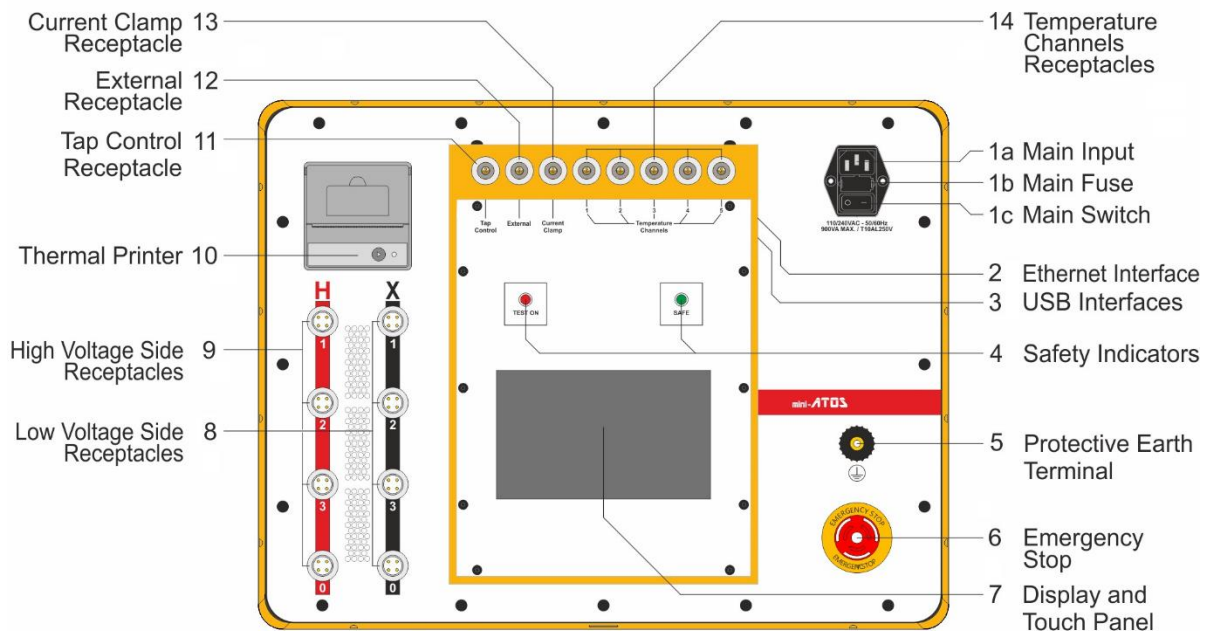

6.1 Mains Input, Fuse and Mains Switch

- a- Connect the power cable to the Mains Input. Use only a standard C13 type connector. The cable must be rated at least 10A.
- b- Two 5mm x 20mm T10A slow blow fuses protects the device. Use only the same type for replacement.
- c- Press the Mains Switch to turn the mini-ATOS ON/OFF.

6.2 Ethernet Interface

This port can be used for remote access. Please see chapter 11 for more information about the remote connection.

6.3 USB Interfaces (1x Host, 2x Device)

1x USB Host, 2x USB Device

6.4 Safety Indicators

Green Light ON: The system is in safe mode. Ready for handling test leads and connections.

Red Light ON: Unsafe mode! Don't remove any cables, the current is flowing and there is a hazardous voltage on the test leads!



WARNING!

The transformer is not discharged!

6.5 Protective Earth Terminal

Use this terminal to connect a protective earth line.

6.6 Emergency Stop

Press to Stop. The measurement will cease and halt Voltage to the test leads immediately.
Turn clockwise to release. The device will remain in a safe state.

6.7 Display and Touch Panel

The mini-ATOS can be easily controlled by this touch screen panel. Since it is a capacitive touch screen, use your finger to control it as you work with a smartphone.

If preferred, an external mouse and keyboard can be connected to the USB Port.

6.8 Low Voltage Side Receptacles

To connect the instrument to the low voltage side terminals of a test object.

6.9 High Voltage Side Receptacles

To connect the instrument to the high voltage side terminals of a test object.

6.10 Thermal Printer

Allows you to quickly get your results on paper by using the built-in thermal printer.

6.11 Tap Control

This port is used for an external connection to a tap changer dry contact. With this connection, the tap position can be changed from the mini-ATOS.

6.12 External

This port is multi-functional and consists of the following functions:

- connecting an external warning device like a warning lamp.
- connecting a tap changing hand switch.
- connecting an external safety interlock like a safety door or a safety hand switch (Only 6pin version).

6.13 Current Clamp Receptacle

This port can be used for connecting an optional current clamp. This current clamp is used for additional measuring features such as DRM motor current.

6.14 Temperature Channels Receptacles

These 5 receptacles are for connecting the external temperature probes.

7 User Interface

7.1 Home Screen

On the home screen, easy access to the main parts of the operation menu is provided. Figure 6 represents the mini-ATOS home screen.

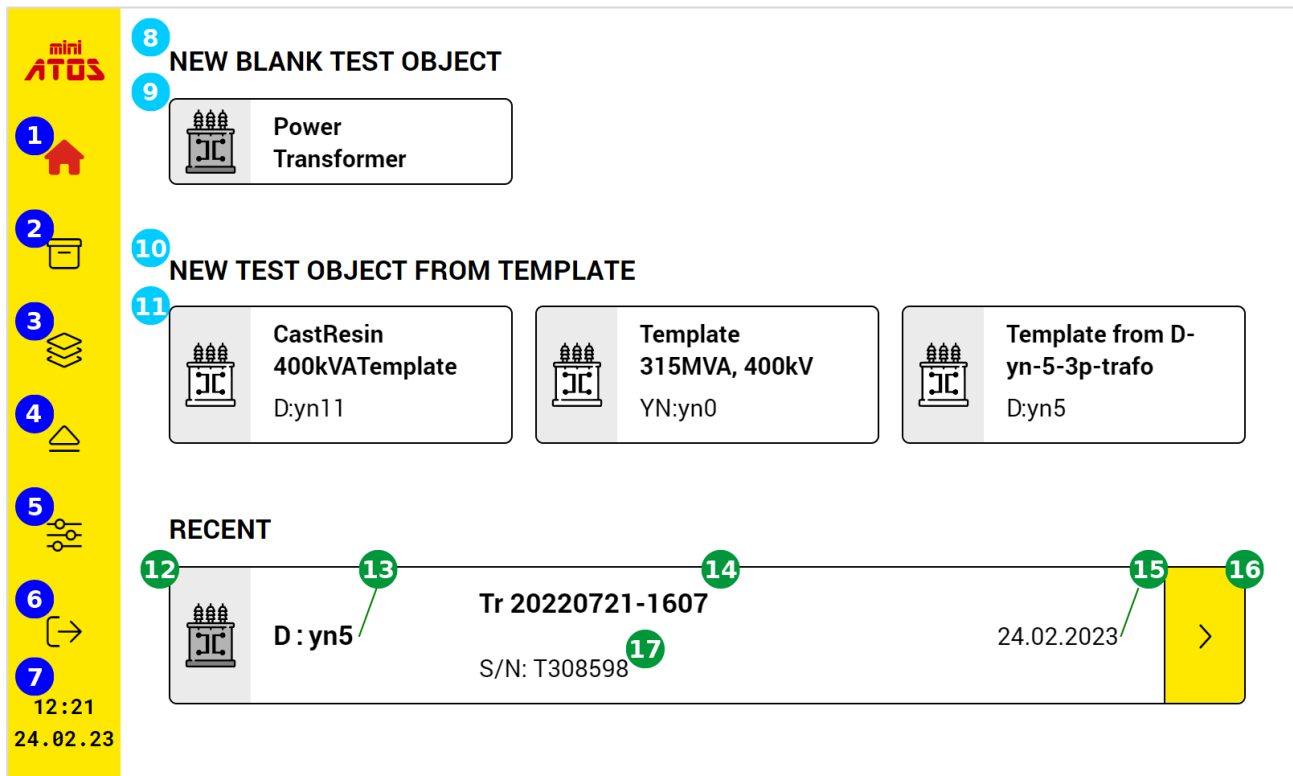

Figure 6: The mini-ATOS home screen

- 1 By tapping the Home icon from any page, you will jump to the Home Screen
- 2 Archive button, which is used to access all previously defined test objects. Please see chapter 7.2 for more details
- 3 Access all test object templates and manage them. Please see chapter 7.3 for more details
- 4 To remove safely the USB stick
- 5 Settings button to access the device settings. Please see chapter 7.4 for more details
- 6 By tapping this button, you will log out and it is possible to activate the remote connection. For more details about the remote connection, see chapter 11
- 7 Date and time
- 8 List of test object types to define a new blank one. Please see chapter 8 for more details
- 9 To define a new power transformer test object
- 10 List of favorite templates, to define a test object from a template. See chapter 7.3 to find out how to define a template
- 11 A test object template item
- 12 Most recent active profile

- 13 Connection and vector group
- 14 Test object name
- 15 Last measuring date
- 16 Jump to the last active measurement window
- 17 Test object serial number

7.2 Archive

In Archive, a list of already defined test objects is shown (Figure 7).

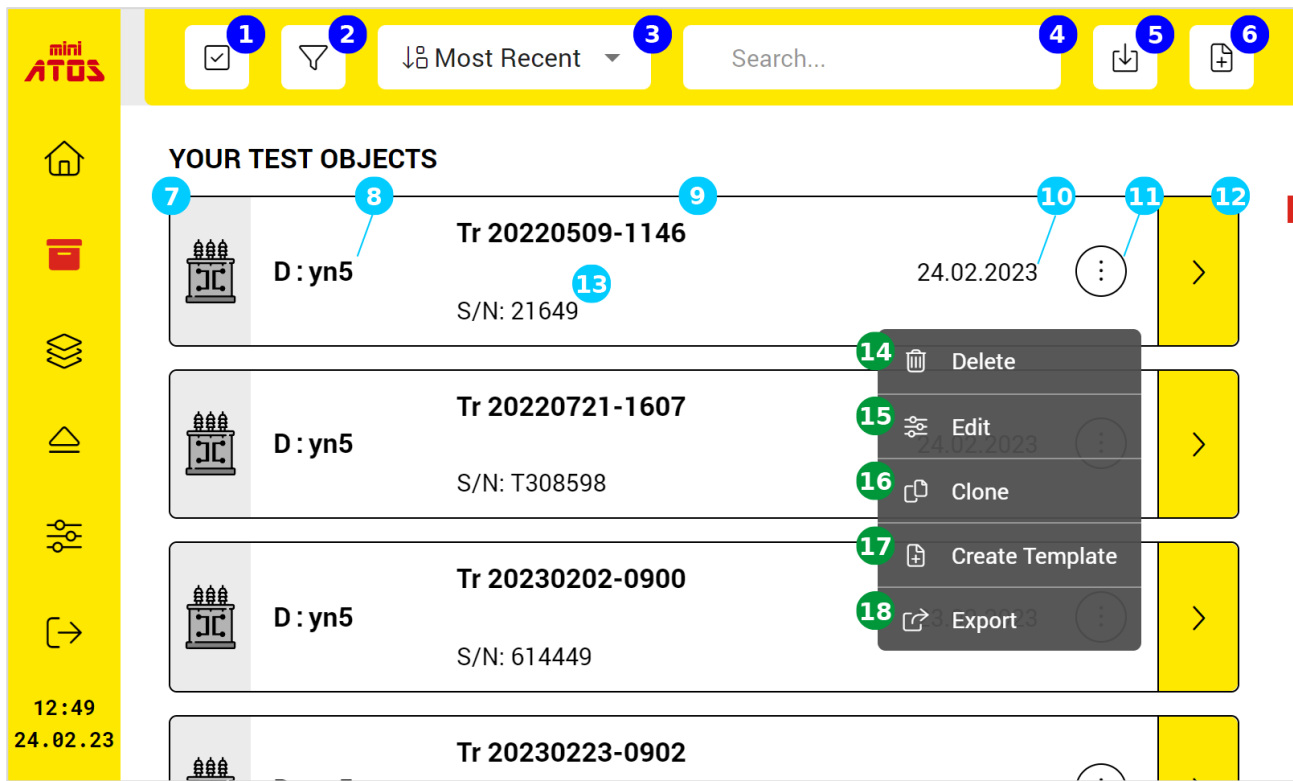

Figure 7: The mini-ATOS test objects Archive

- 1 To activate the multiselect to export or delete test objects
- 2 Filter the test object records
- 3 Sort the test object records based on various fields
- 4 Search tool to find a test object from the list. The search word can be the name, serial number or winding connection type
- 5 To import a test object from the connected USB stick
- 6 To create a new test object
- 7 Test object record
- 8 The test object winding configuration
- 9 Test object name
- 10 Last activity date
- 11 To open the option menu
- 12 Open the test object
- 13 Test object serial number
- 14 To delete the test object
- 15 To edit the test object
- 16 To clone the test object

- 17 To create a template from the test object (See chapter 7.3 for more information)
- 18 To export the test object to a USB stick

By opening each test object, the history of the inspections and test plan measurements will be displayed as in Figure 8.

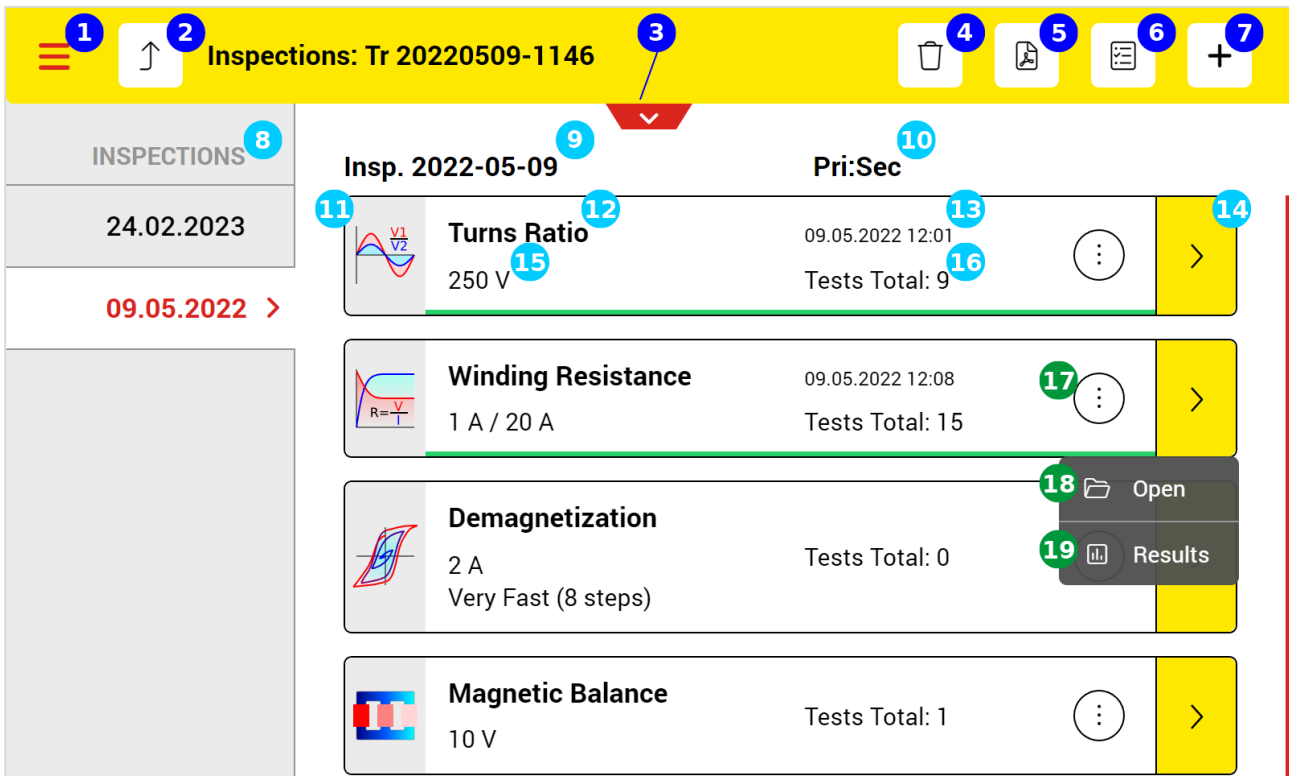



Figure 8: List of measurements for each test object in Archive

- 1 To open the main menu
- 2 To go back to the Archive
- 3 Open test object quick access
- 4 To delete the selected inspection
- 5 To generate and export the PDF report
- 6 To jump to the test plan page and perform the measurements
- 7 To add a new inspection
- 8 The list of inspections sorted by date
- 9 The selected inspection title
- 10 The selected test plan measurement sides
- 11 The test plan measurement item
- 12 The measurement type
- 13 The Last measuring date and time
- 14 To open the result view in graph and table

- 15 The measurement setting
- 16 The total tests possible for the measurement
- 17 To open the option menu
- 18 To open the measurement view
- 19 To open the result view in graph and table

7.3 Templates

When there are some test objects with the same specifications, it is good to make a template for all of them. Later it is possible to use the template to define each test object easier and faster by avoiding entering the same information each time.

Figure 9 shows the template list. To create a new template, just tap the add button  and input the template data the same as to create a new test object (See chapter 8). You can then save it and jump to the test plan page. Test plan is also a part of the template. It is possible to adjust the test plan including the measurement settings.

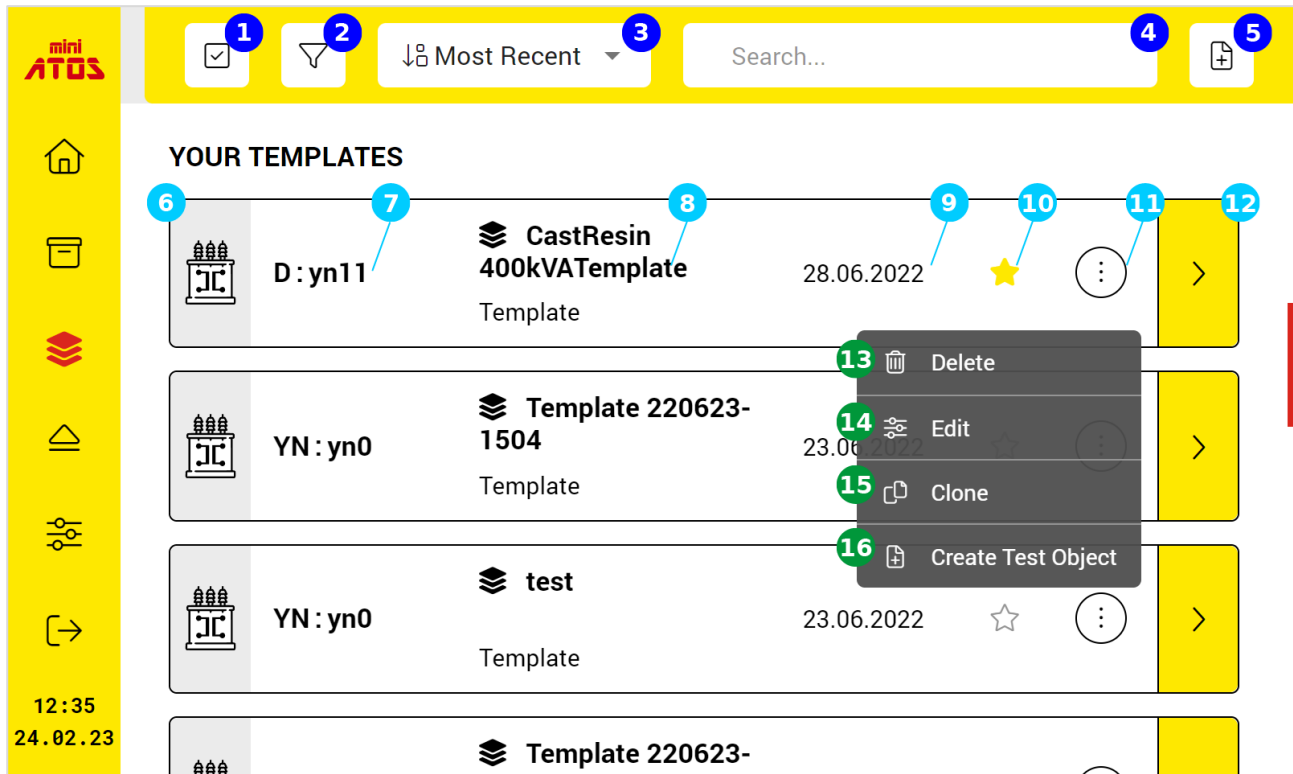

Figure 9: Test object templates

- 1 To activate the multiselect to delete more templates together
- 2 Filter the test object records
- 3 Sort the template items based on various fields
- 4 Search tool to find a template from the list. The search word can be the name or the winding connection type
- 5 To create a new template
- 6 Template item
- 7 The template winding configuration
- 8 Template name
- 9 Date created
- 10 When it is marked, it will be shown on the home screen
- 11 To open the option menu

- 12 To open the template and edit the template test plan
- 13 To delete the template
- 14 To edit the template
- 15 To clone or make a copy from the template
- 16 To create a test object from the template

7.4 Settings

7.4.1 Date and Time

In this tab, Date and Time and related settings like Country and Time zone can be adjusted. Simply you can tap each field and change its values.

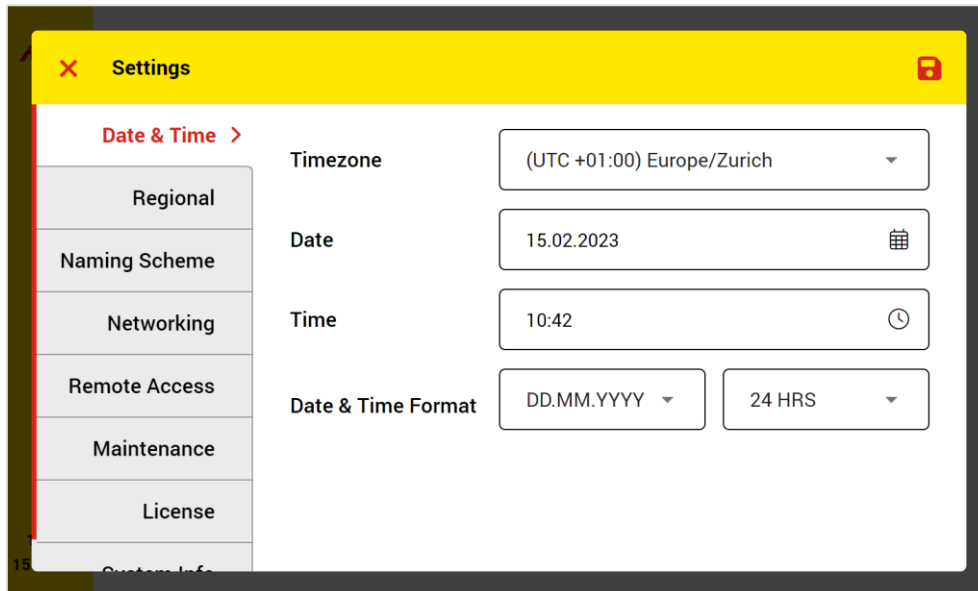

Figure 10: Date and time adjustment in Setting

7.4.2 Regional

The user interface language, default temperature unit format, numbers decimal separator and CSV separator can be selected in the Regional tab (Figure 11).

CSV separator is helpful for software like excel to correctly show results as data columns from the exported results in CSV format. Depending on the PC language, sometimes comma [,] is the separator and sometimes semicolon [;] is the separator.

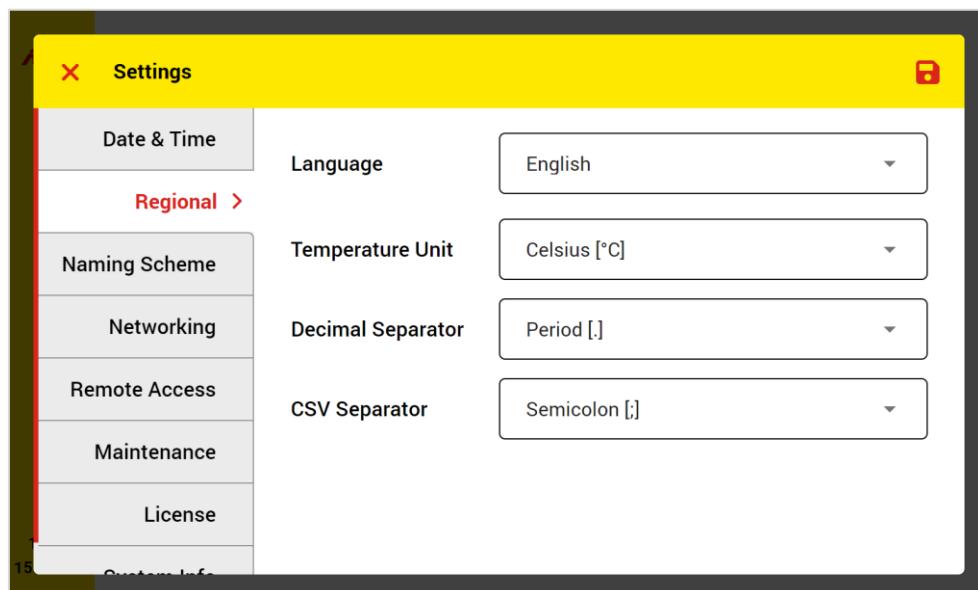

Figure 11: Regional adjustments in Setting

7.4.3 Naming Scheme

In the Naming Scheme tab (Figure 12), it is possible to set the default naming scheme of a new test object. Generally, there are different systems of terminal naming for each test object. There is also a custom naming scheme which can be easily edited to use it later.

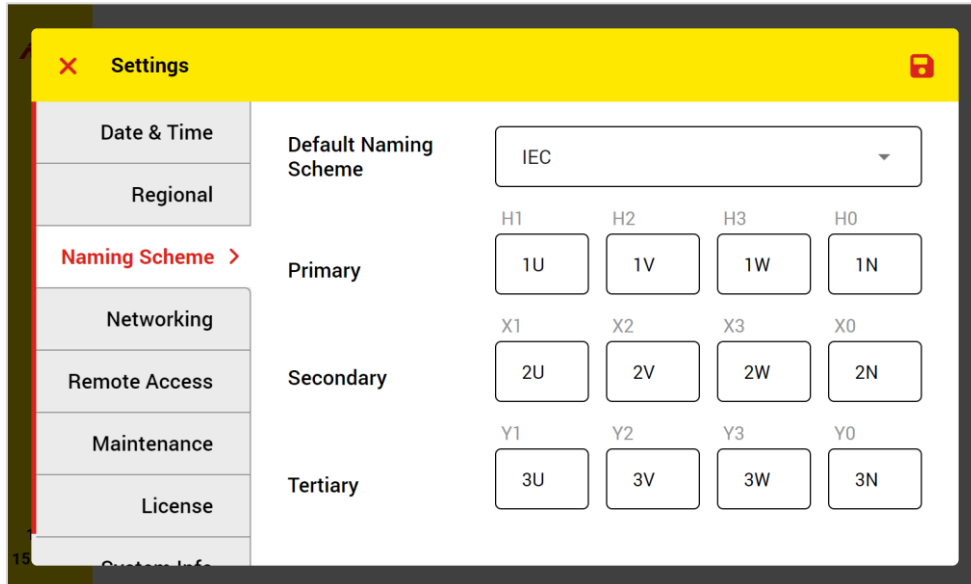

Figure 12: Default Naming Scheme adjustment

7.4.4 Networking

In this tab (Figure 13), you can adjust the networking settings which are required for remote access. For more information about remote access please see chapter 11.

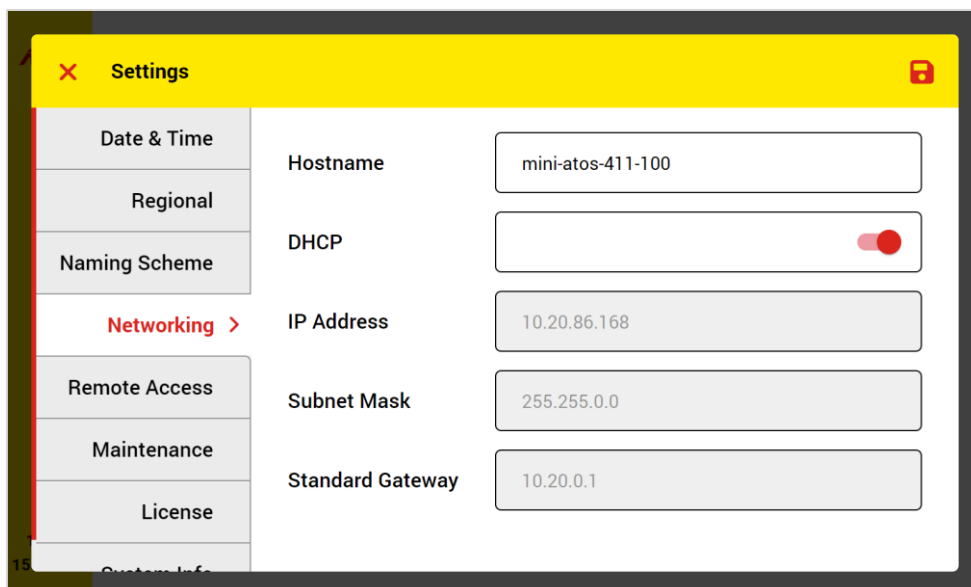

Figure 13: Network configuration

Hostname

The system usually assigns the Hostname automatically according to the device serial number. It is also possible to change this name. This name will be used as the address (`http://"Hostname"`) to access the device remotely via Ethernet connection. Please see chapter 11 for more information.

DHCP

When DHCP (Dynamic Host Configuration Protocol) is activated, the system configures the network automatically and the user doesn't need to do it manually.

IP Address, Subnet Mask, Standard Gateway

Here you can configure the network manually by entering the required fields.

7.4.5 Remote Access

Here there are remote access settings which are required to be adjusted (Figure 14). To see the remote access guide, please see chapter 11.

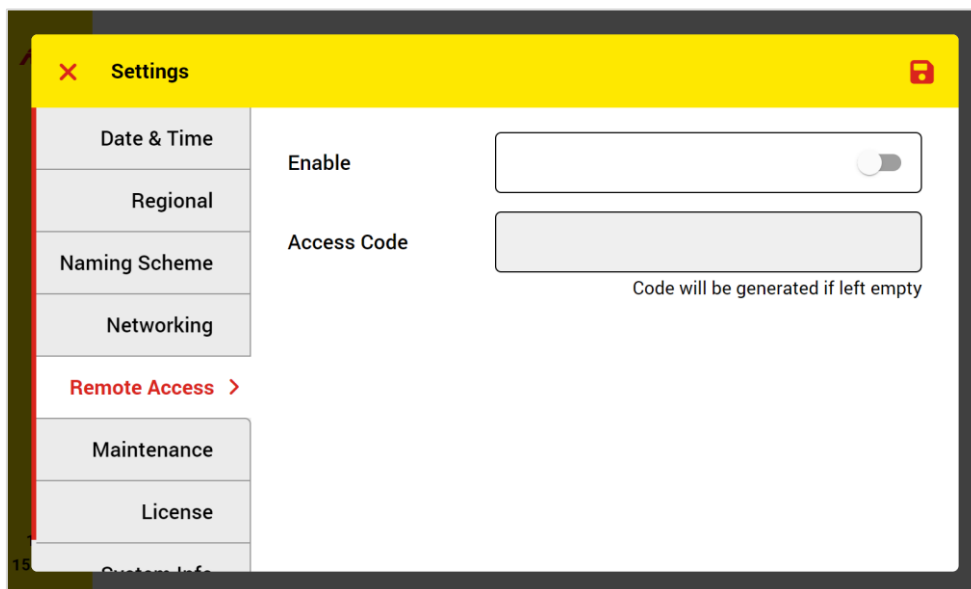

Figure 14: Remote Access settings

Enable

Use this toggle button to enable or disable remote access.

Access Code

Because of security, an access code is always required to log in to the software. The access code can be set manually by entering the intended number (6 digits) or the code will be generated automatically (4 digits) if the field is left empty. The generated code will be shown on the login page on the device screen. To find out how to control the device with remote access, please see chapter 11.

7.4.6 Maintenance

Figure 15 shows the maintenance tools and each one is explained below.

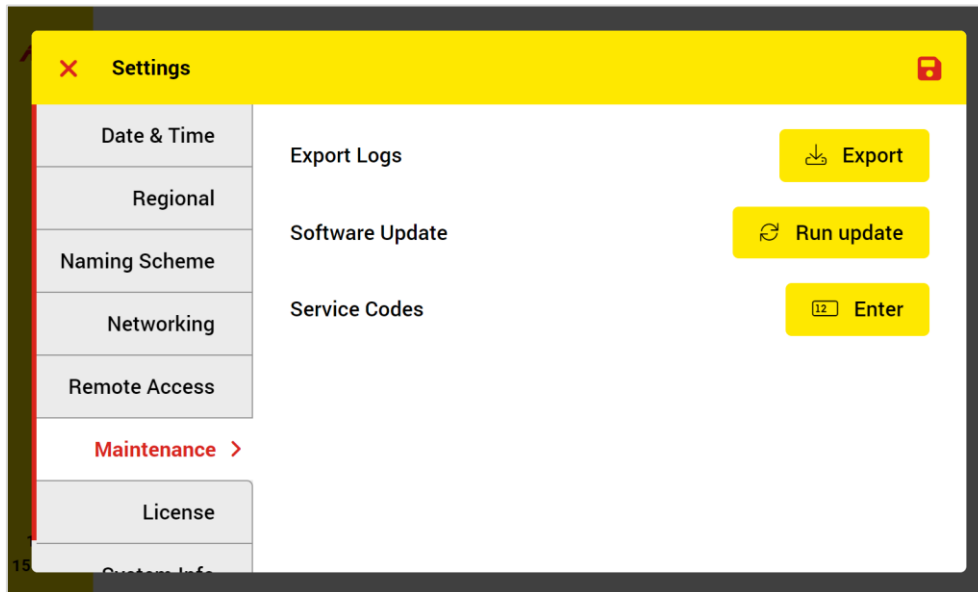

Figure 15: Maintenance tools

Export Logs

When it is required to diagnose the mini-ATOS software, the Raytech service team may ask you to export logs. To export the logs, just connect a USB stick and tap the Export button. You can later send the exported log file to the Raytech service team.

Software Update

When a new software or firmware update is available, you can copy the update file to a USB stick and connect it to the device. Then tap the Run update button and wait until the process is finished. Please do not turn off the device or unplug the USB stick during the update! The update can take up to 10min.

Service Codes

When there is a problem or error in the device, the Raytech service team may ask you to use the service codes. With service codes, it is possible to do some additional actions which are not possible to do by using the default software. These actions can be for example a self-test for diagnosing the hardware.

7.4.7 License

To activate the main firmware functionality or a specific optional measurement feature, you have to add a license code in this tab (Figure 16). Just tap the Add  button and enter the license code. Each license may be valid for a limited time like 10 days or can be unlimited.

To test a feature, you can ask Raytech for a trial license to activate the feature temporarily.

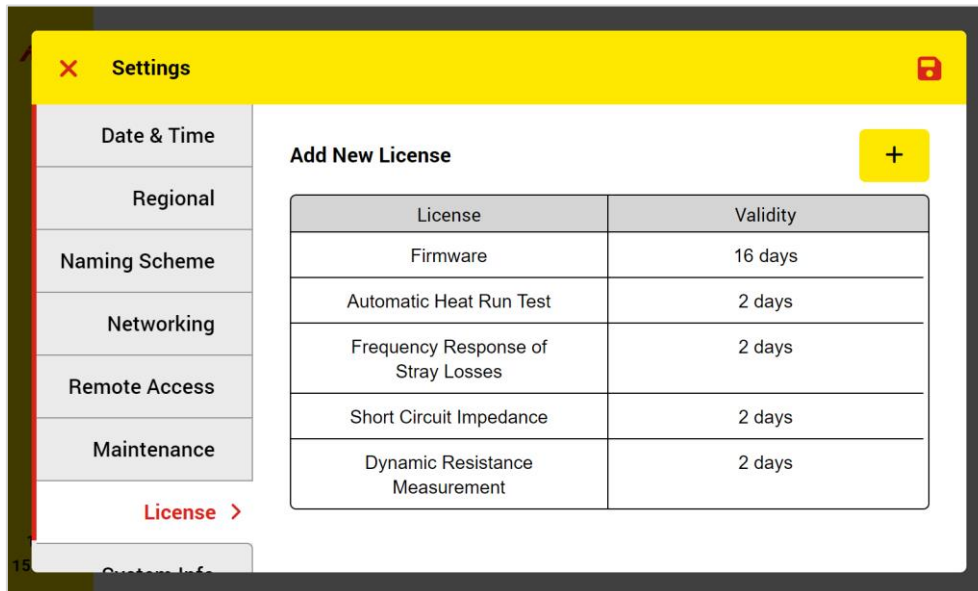

Figure 16: License manager

7.4.8 System Info

In system info, you can check the actual Operation system and firmware versions, the device serial number and calibration information.

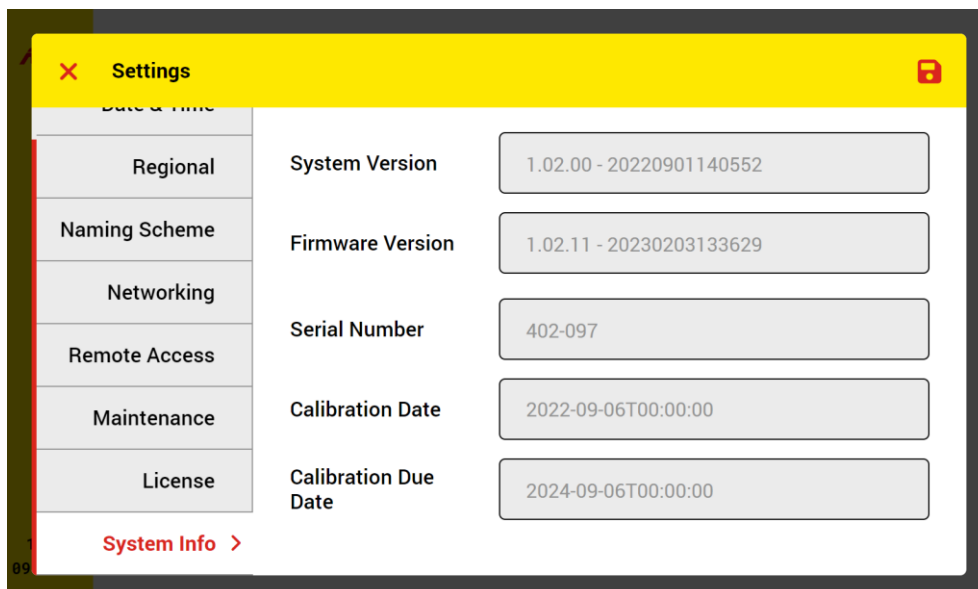

Figure 17: System Information

8 Test Objects

8.1 Power Transformer

In the TEST OBJECT window, a new test object can be defined or an existing test object can be modified. Figure 18 represents the test object window.

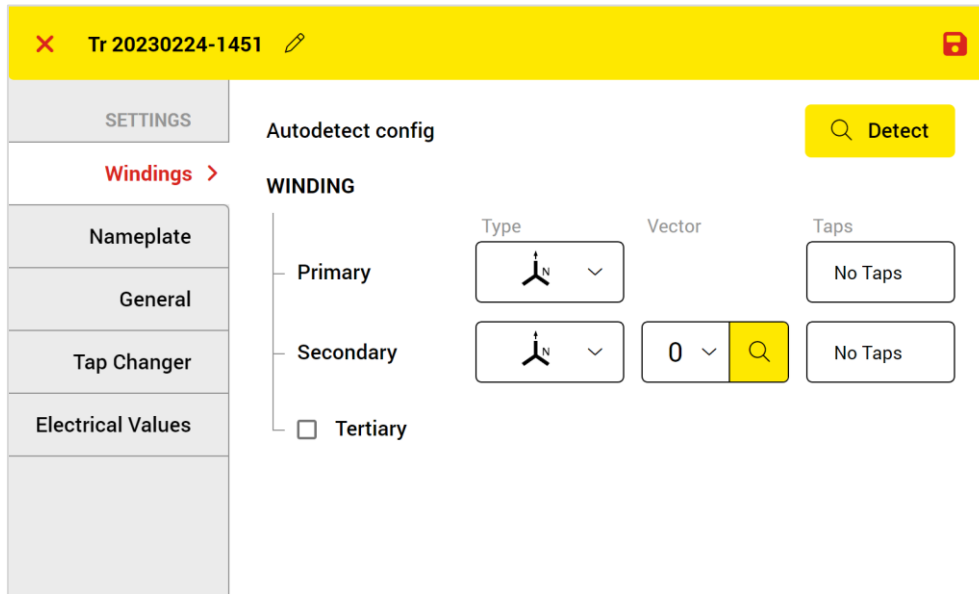



Figure 18: The test object window

Test Object Name

Tr 20220502-1501 

Name of the test object, which is helpful for easy identification. The system always assigns an automatic name at the beginning which consists of the test object type, date and time. This name can be easily changed by tapping the pencil symbol or the name.

 **Save**

Tap the Save icon to store all the entered test object data and go to the test plan.

 **Cancel**

By tapping this icon, you can cancel the test object defining and go back to the Home Screen. Please take care because all the entered data will not save.

8.1.1 Windings

In the Windings tab (Figure 19), the most important properties of the test object, including winding types, vector groups and the number of taps can be defined. After creating the test object, it is not possible to make changes in the winding information.

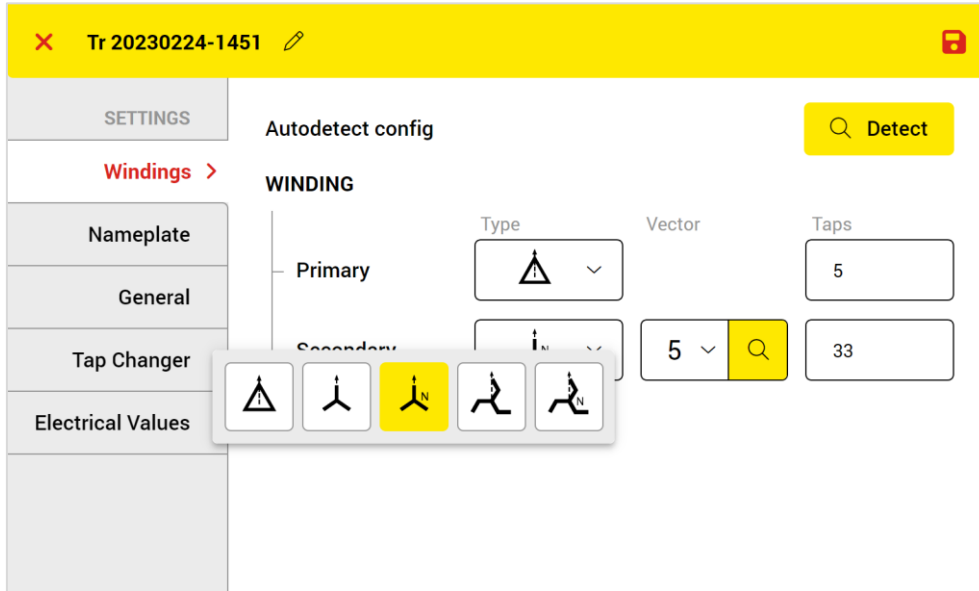







Figure 19: Test object windings tab

You can select the winding type by tapping the winding connection symbol for each winding side. The winding type for a power transformer can be from any winding type of Table 5.

Table 5: Winding types and symbols for power transformer

Phases	Type	Letter (Primary)	Letter (non-Primary)	Symbol
3-Phases	Delta	D	d	
	Star with accessible neutral	YN	yn	
	Star	Y	y	
	Zigzag with accessible neutral	ZN	zn	
	Zigzag	Z	z	
1-Phase	Single-phase	S	s	

 Detect

By tapping the Detect button, the transformer winding configuration detection window will be opened and it is possible to find the winding configuration and vector group by measurement automatically. Please see chapter 8.1.2 for more details.

For all non-Primary windings, the vector group must be correctly selected. It is really important to make sure that the vector group is correct because the switching function of the automatic multiplexer is based on the vector group and winding type.

 **Detect Vector Group**

It is also possible to detect just the vector group quickly by using this button. It detects only the vector group and not the winding configuration.

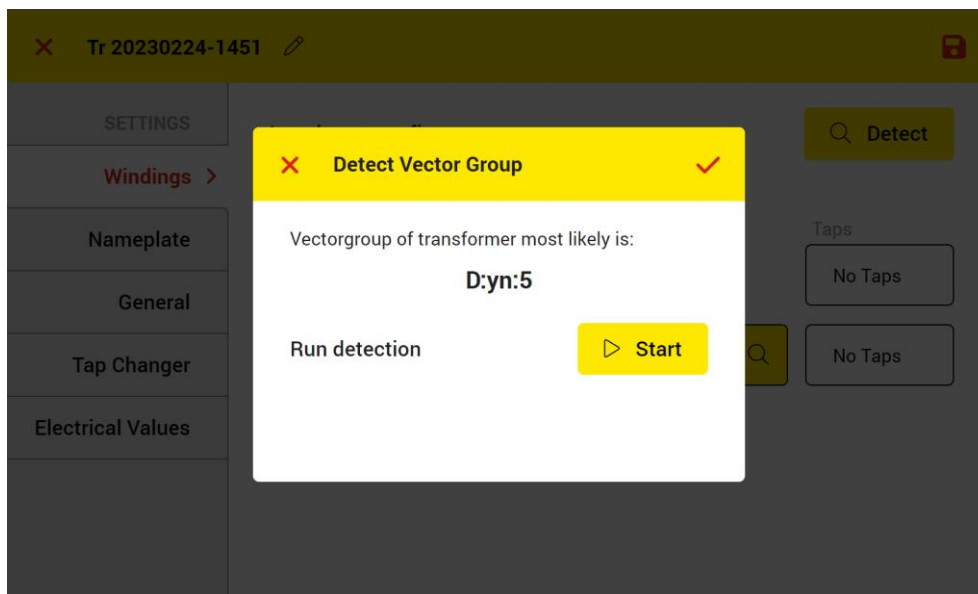

Figure 20: Detect vector group

For each winding, when there are several taps, the number of taps can be entered by clicking on the taps column. In the tap count window (Figure 21) the tap numbers can be easily adjusted. You can also enter the number of taps directly with the virtual keyboard by tapping the taps number directly.

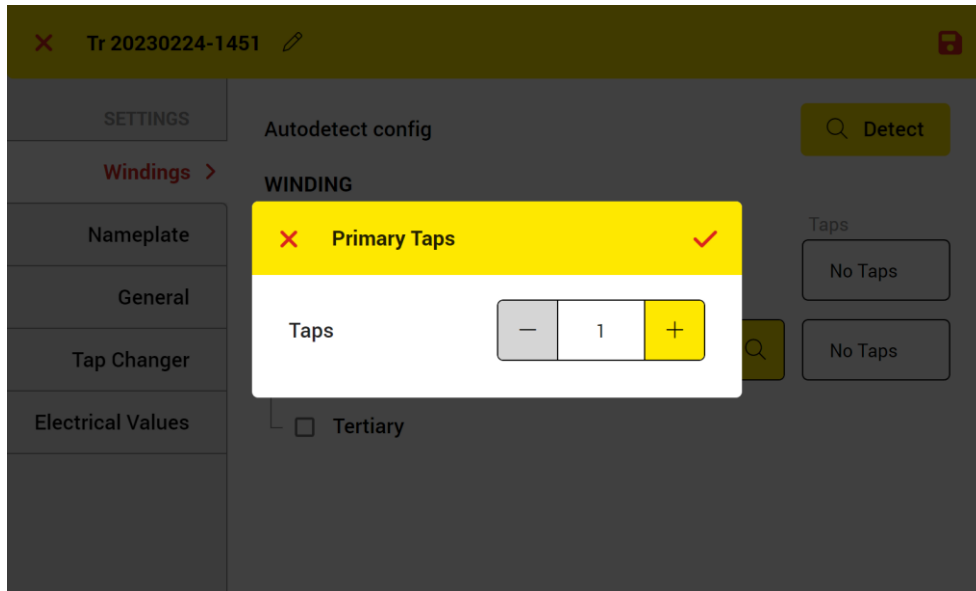

Figure 21: Tap count configuration window

When there is a tertiary winding, the check box can be selected and like the secondary winding, the required information can be entered (Figure 22).

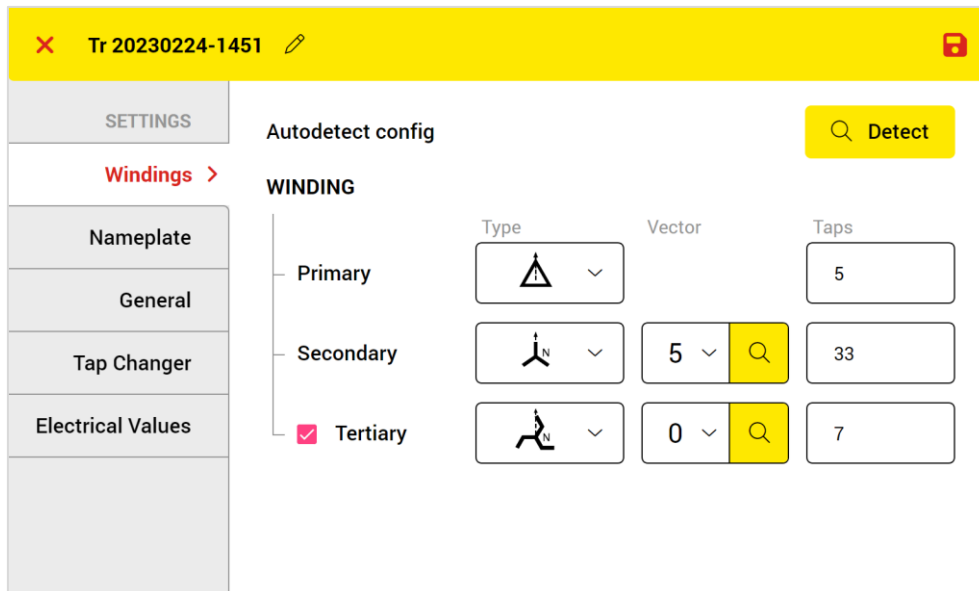

Figure 22: Defining a transformer with a Tertiary winding

8.1.2 Winding Configuration Autodetect

Autodetect feature can detect the winding configuration and vector group of the test object. During detection, the test cables must be connected to the test object terminals according to 5.1.

By tapping the Detect button in the test object windings tab (Figure 19) a new window will be opened (Figure 23). To perform the transformer detection, tap the Start and wait until mini-ATOS find the configuration.

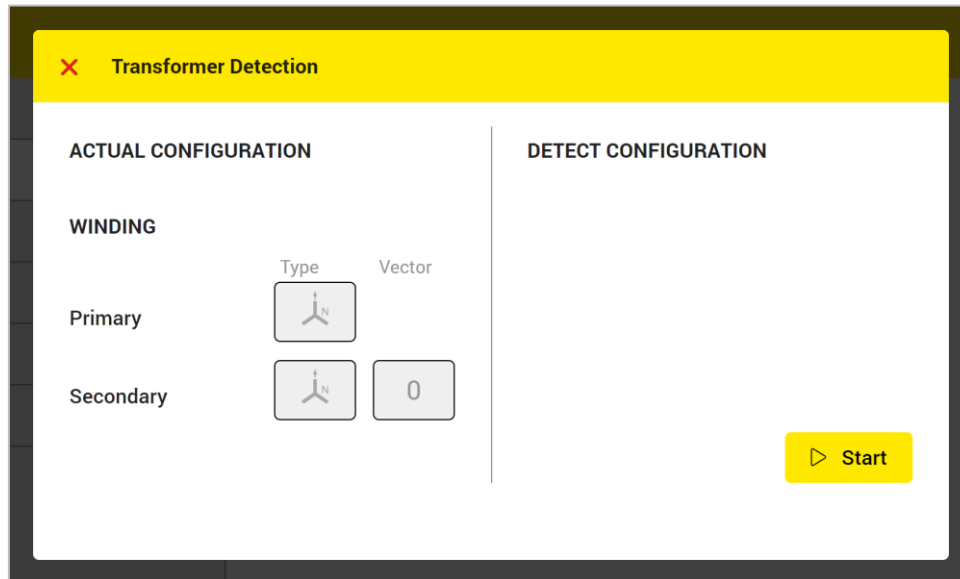

Figure 23: Winding configuration autodetect window

The actual configuration is written on the left side, and the detected configuration will be written on the right side (See Figure 24). When mini-ATOS find more winding configurations, a list of them will be provided and you can choose each of them. After detection, you can accept the detected configuration or you can cancel.

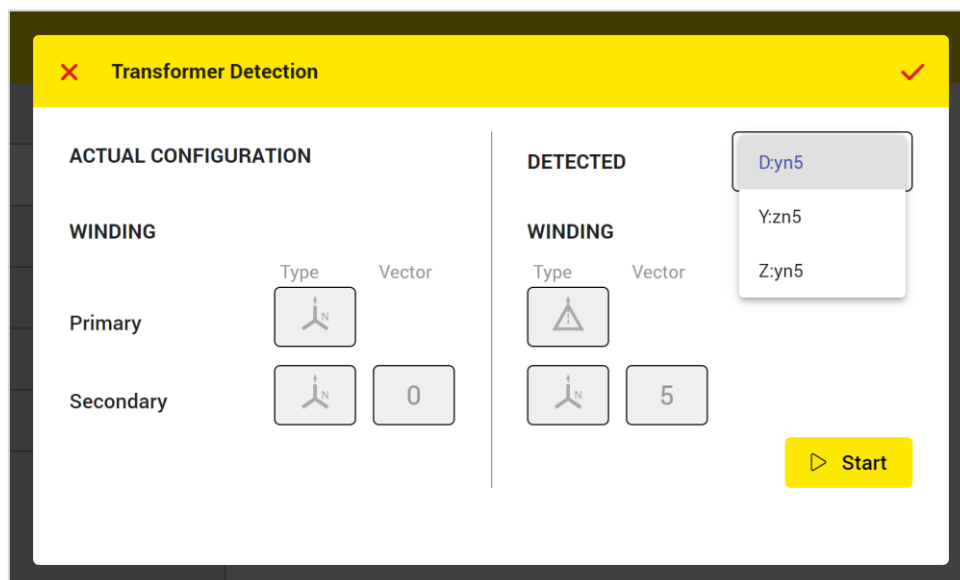
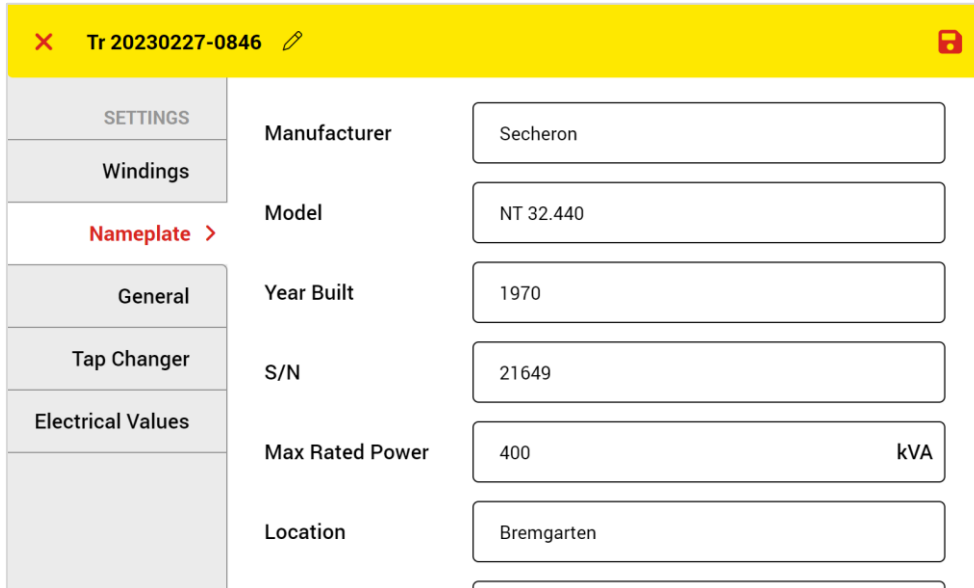

Figure 24: Winding configuration autodetect window after detection

8.1.3 Nameplate

Figure 25 shows the Nameplate tab. When nameplate data is available, it can be entered in this part. By tapping each text field, the keyboard will be opened and the data can be easily entered. The nameplate data is optional to enter. It is also possible to add this information later by editing the test object.



Tr 20230227-0846	
SETTINGS	Manufacturer: Secheron
Windings	Model: NT 32.440
Nameplate >	Year Built: 1970
General	S/N: 21649
Tap Changer	Max Rated Power: 400 kVA
Electrical Values	Location: Bremgarten

Figure 25: Test object Nameplate tab

8.1.4 General

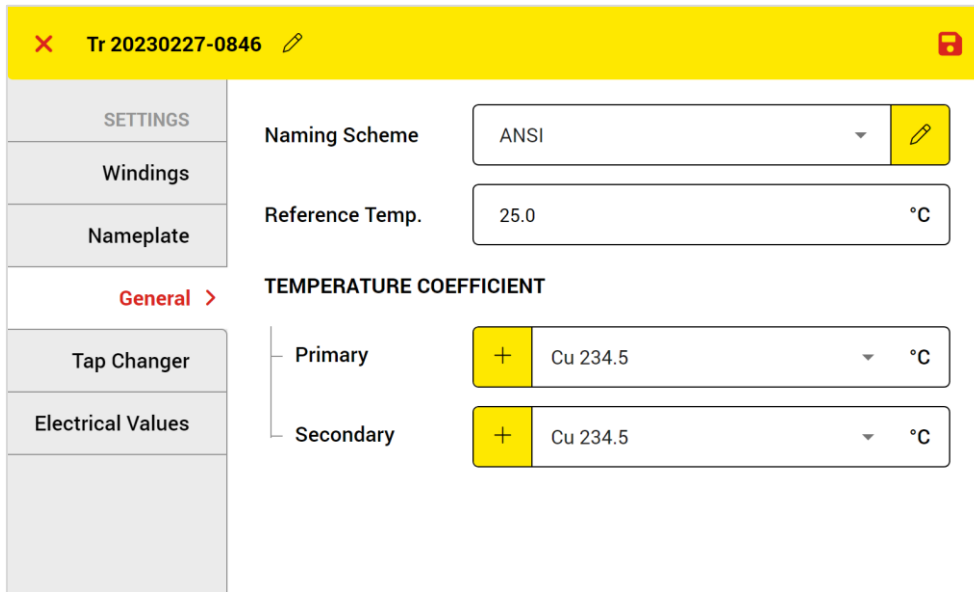

Figure 26: Test object General tab

In the test object general tab (Figure 26), the following information can be entered.

Naming Scheme

Generally, there are different systems of terminal naming for each test object. The naming scheme of the current test object can be selected here. When a custom naming scheme is required, it can be easily defined in the Naming Scheme window (Figure 27) which can be opened using the pencil icon.

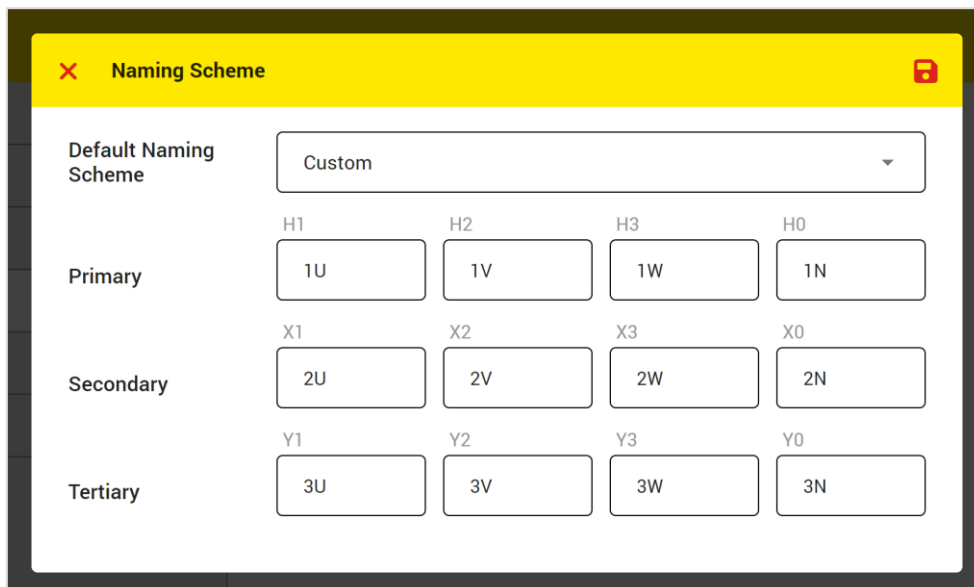

Figure 27: Custom Naming Scheme window

Reference Temperature

The reference temperature which is required for the temperature correction can be set here. For more details about the temperature correction principle, please see chapter 4.2.2.

Temperature Coefficient

The temperature coefficient which is required for the temperature correction can be set here for each winding. If a custom coefficient is required, the value can be added using the plus icon. For more details about the temperature coefficient, please see chapter 4.2.2.

8.1.5 Tap Changer

In the tap changer tab (Figure 28), the tap changers type for each winding side, possibility to control the tap changer automatically and the maximum tap changing transition time can be entered. These are especially useful when the user would like to use the automatic tap control feature.

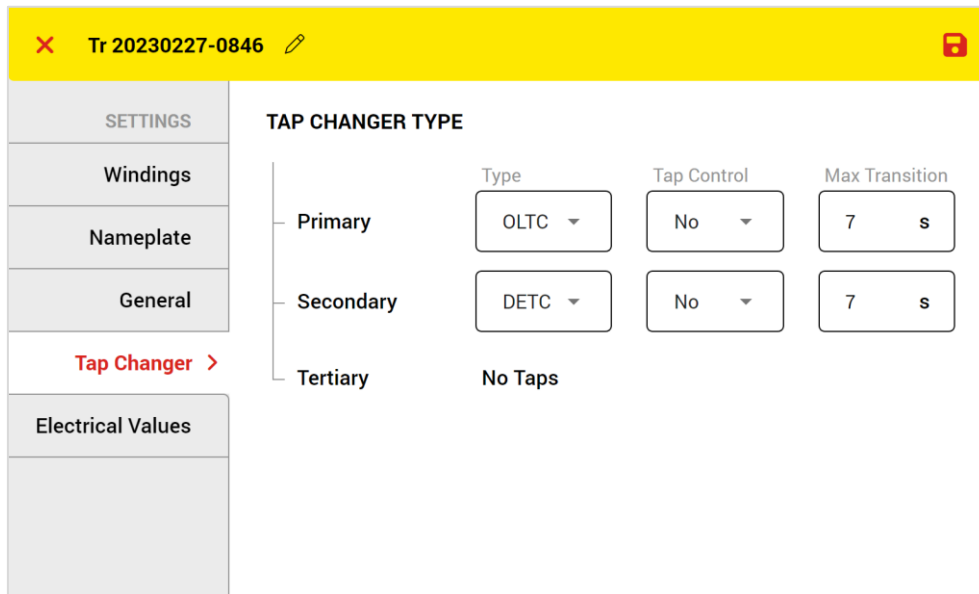

	Type	Tap Control	Max Transition
Primary	OLTC	No	7 s
Secondary	DETC	No	7 s
Tertiary	No Taps		

Figure 28: Test object tap control tab

Type

When there is more than one tap for a winding side, it means that the winding is equipped with a tap changer. Tap changers can be categorized in two main types: DETC and OLTC. DETC (DeEnergized Tap Changer) which can operate only when the transformer is not energized and OLTC (On Load Tap Changer) which can operate even when it is energized.

It is also very important to select the tap changer type correctly. For OLTC, it is possible to measure the DC resistance for several taps (please see chapter 11) without turning off the DC power supply.

Tap Control

If you connect the mini-ATOS tap control output to the tap changer control unit, choose Yes. The tap changer position then can be changed manually or automatically from the mini-ATOS. To find out how to connect the tap control cable, please refer to chapter 13.5.

Max Transition

The maximum transition time which it takes for a tap changer with a motor to change the tap position.

8.1.6 Electrical Values

In the test object electrical values tab (Figure 29), the rated voltage and label for each tap can be entered. The Rated Voltages later will be used as reference values for turns ratio relative error calculations and Labels will be used as tap names.

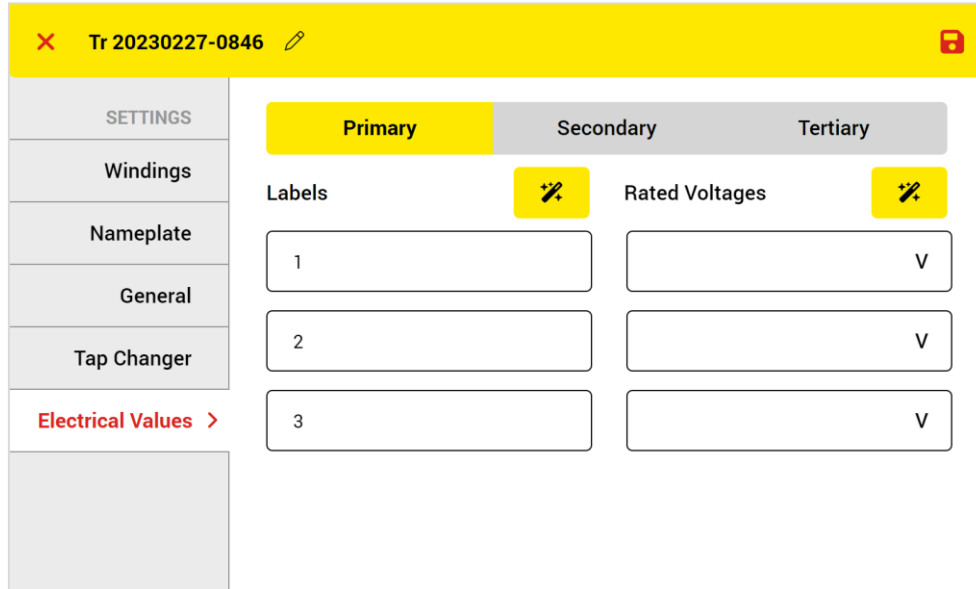

Figure 29: Test object Electrical Values tab

For each winding, the nominal voltage value and label of each tap should be entered. It is also possible to use wizards to enter the values easier. Following example, by using the power transformer with tap information according to Table 6, explain how they work.

Table 6: Example: power transformer information

Primary Taps		Secondary Taps					
Label	Voltage [V]	Label	Voltage [V]	Label	Voltage [V]	Label	Voltage [V]
1	70350	16R	14399	5R	13499	6L	12599
2	68675	15R	14317	4R	13417	7L	12517
3	67000	14R	14235	3R	13335	8L	12436
4	65325	13R	14154	2R	13254	9L	12354
5	63650	12R	14072	1R	13172	10L	12272
		11R	13990	N	13090	11L	12190
		10R	13908	1L	13008	12L	12108
		9R	13826	2L	12926	13L	12026
		8R	13745	3L	12845	14L	11945
		7R	13663	4L	12763	15L	11863
		6R	13581	5L	12681	16L	11781

Rated Voltages Wizard

In the Rated Voltages Wizard, there are two calculation methods:

First/Last method

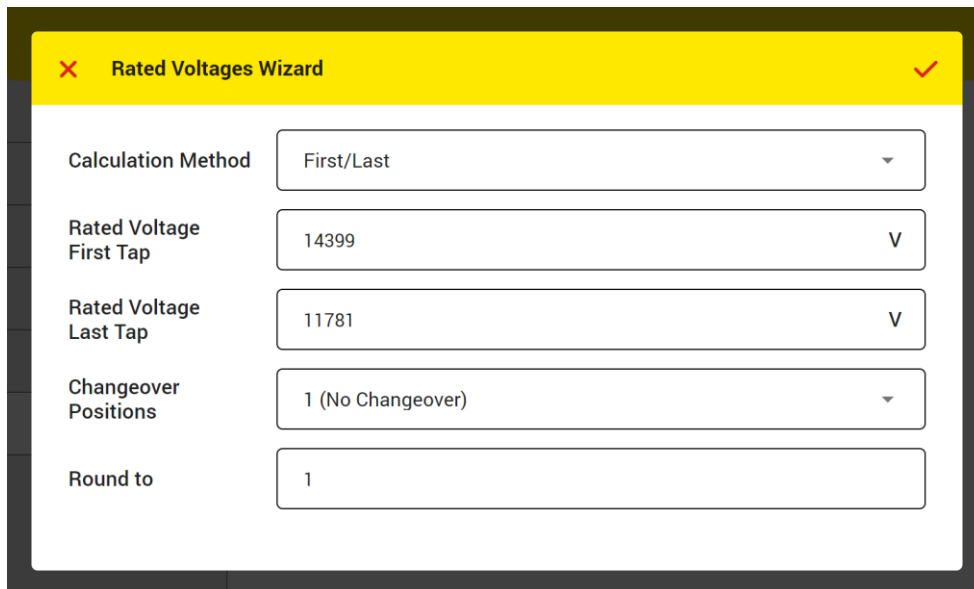

The screenshot shows a software window titled "Rated Voltages Wizard" with a yellow header bar. The window contains five input fields:

Field Name	Value	Unit
Calculation Method	First/Last	
Rated Voltage First Tap	14399	V
Rated Voltage Last Tap	11781	V
Changeover Positions	1 (No Changeover)	
Round to	1	

Figure 30: Rated Voltage Wizard, First/Last method

In this method, we have to enter the first tap and the last tap Ph-Ph nominal voltage. Figure 30 shows how to fill the form for the secondary side of the example.

Some transformers have tap changer changeover with more than one tap with the same voltage in the middle. In such cases, the number of changeover positions with the same voltage has to be also entered.

To match the calculated values to nameplate values, it is also possible to say the wizard how to round the calculated values. The default value is 1, which means that all calculated values round to the nearest natural number.

RefTap/Step Method

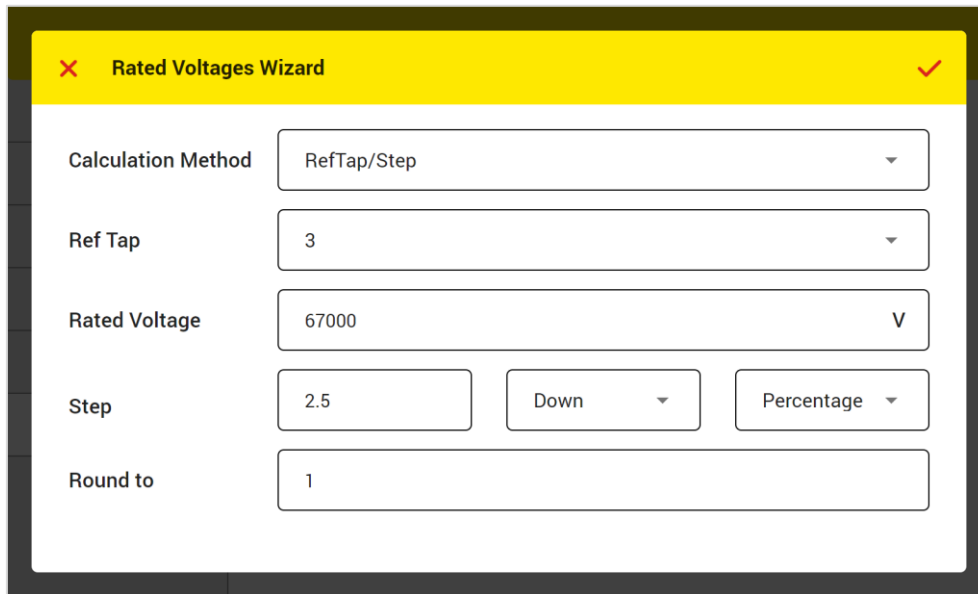

Figure 31: Rated Voltage Wizard, RefTap/Step method

In this method, by entering the rated voltage of the reference tap position and the step value between each two tap positions, all nominal voltages for all tap positions will be calculated and filled out automatically.

The RefTap is the tap position of the transformer rated voltage. The reference tap is usually the middle tap position.

The Rated Voltage is the Ph-Ph rated voltage of the power transformer which is always written on the nameplate.

The step voltage amount can be in V per step or % per step. The amount can be determined from the nameplate by subtracting the voltage values of two consecutive taps which are usually written on the nameplate.

Figure 31 shows how to fill the wizard for the primary side of the example.

When the tap changer is located on the primary side, usually the nominal voltage of the first tap is the highest voltage and for the other taps, the nominal voltage decreases. In this case for the direction, Down must be selected. The opposite is usually valid for the transformers with a tap changer on the LV side and Up must be selected for the Direction.

To match the calculated values to nameplate values, it is also possible to say the wizard how to round the calculated values. The default value is 1, which means that all calculated values round to the nearest natural number.

 **Labels Wizard**

If the default label does not match the actual tap labels, the Labels Wizard will be helpful to define a label for each tap easier. Figure 32 shows the Labels Wizard window. The first item is the Labelling pattern which is used to choose the system of labelling. When there are changeover positions, their labels can be adjusted by using the Changeover suffix item.

When it is required, by editing the Offset, it is possible to start the labelling from any number.

Finally, there is a Preview, which shows how will be the labels by using the wizard.

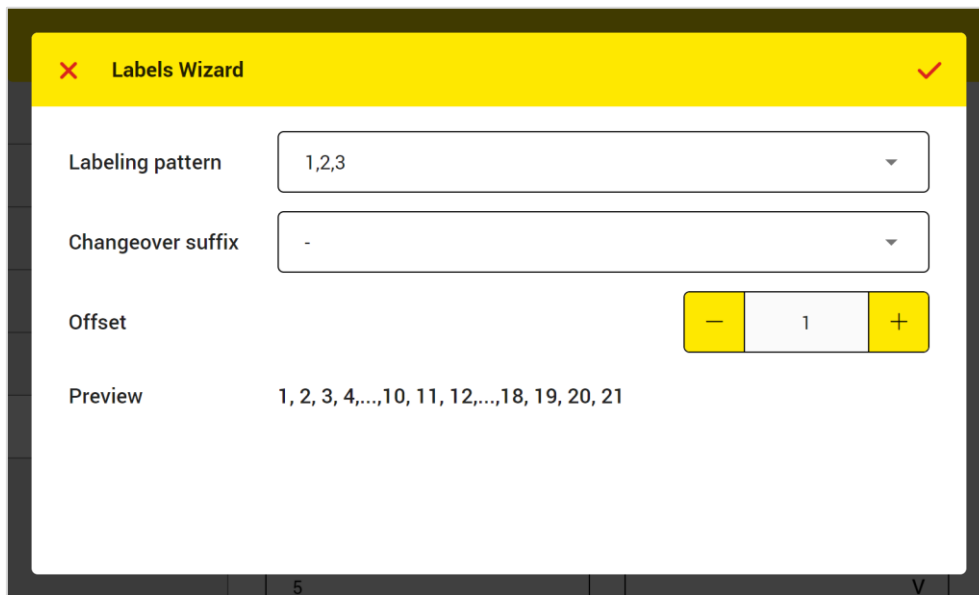

Figure 32: Labels wizard window

Figure 33 shows also how to fill the wizard for the secondary side of the example.

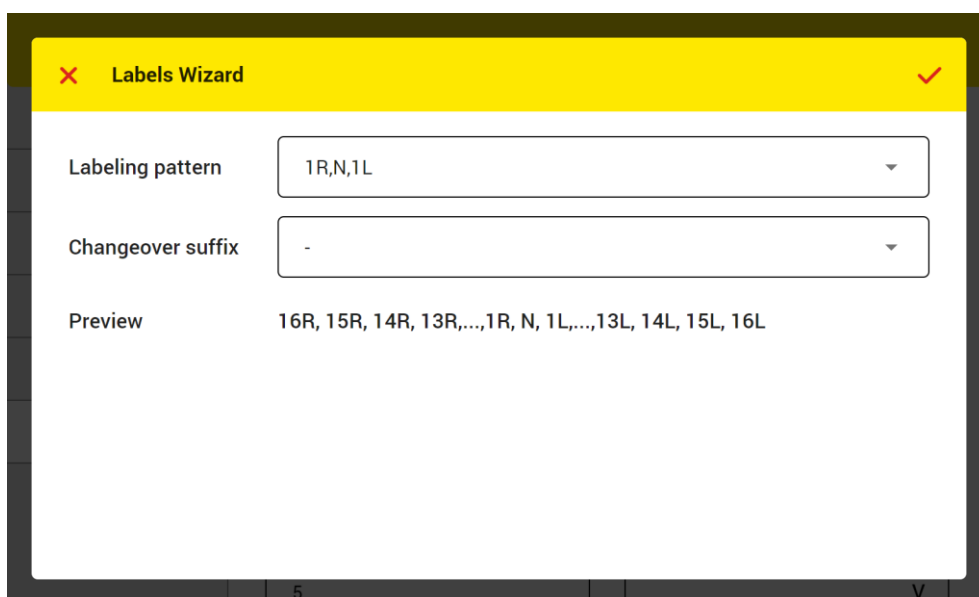







Figure 33: filling the labels wizard for the example

8.2 Auto Transformer

To define a new auto transformer test object, just tap the auto transformer on the home page from the new blank test object part. Defining an auto transformer is like defining a power transformer which is described in chapter 8.1. However, the possible winding configurations are according to Table 7.



Table 7: Winding types and symbols for auto transformer

Phases	Type	Letter (Primary)	Symbol	Letter (Secondary)	Symbol
3-Phases	Star with accessible neutral	YN		Ya	
	Star	Y		Ya	
1-Phase	Single-phase	S		Sa	

9 Inspection and Test Plan

In the lifetime of a high voltage asset, usually a measurement or group of measurements have to be performed periodically and also sometimes occasionally. The aim is to inspect the health condition or to detect the suspected failures. In mini-ATOS, each group of measurements is called a Test Plan which forms an Inspection.

Figure 34 shows an example of a test plan for a 3-phase power transformer. It consists of a turns ratio test, a winding resistance test and a demagnetization.

You can enable the edit mode (Figure 35) to adjust the order of measurements and add or remove them by tapping the edit icon . You can touch and hold the move icon  and try to change the position of each measurement item.

In each measurement item, it can be seen that the measurement Settings and the number of the tests performed from all the tests possible to perform are written. When you tap the measurement settings button , the setting window will be opened from the right side. To find out which settings are there for each measurement, please refer to chapter 10 and see each measurement method settings.

By tapping the yellow right arrow, the measurement view will be opened and from there it is possible to perform the test.

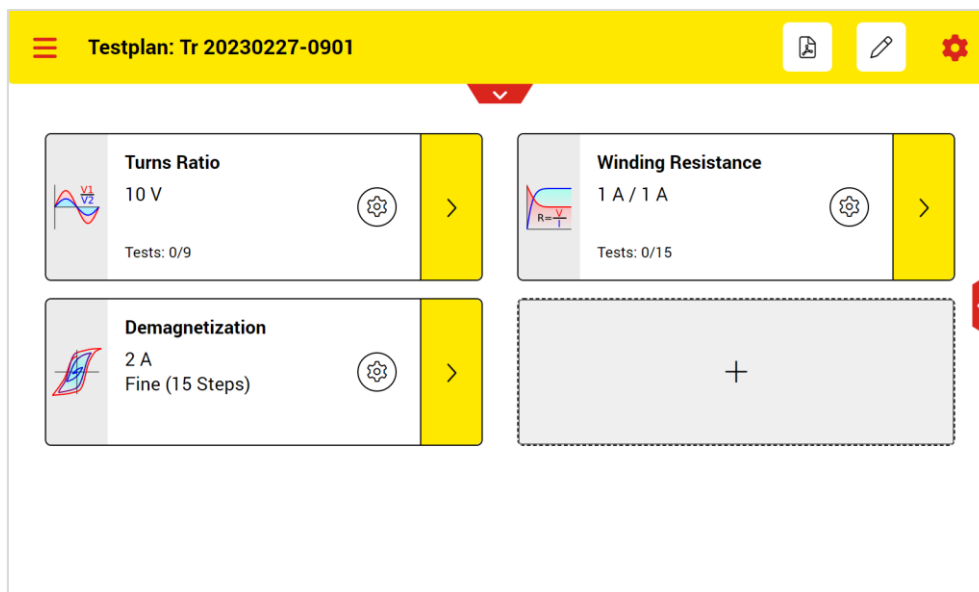

Figure 34: A Test Plan for a 3-phase power transformer

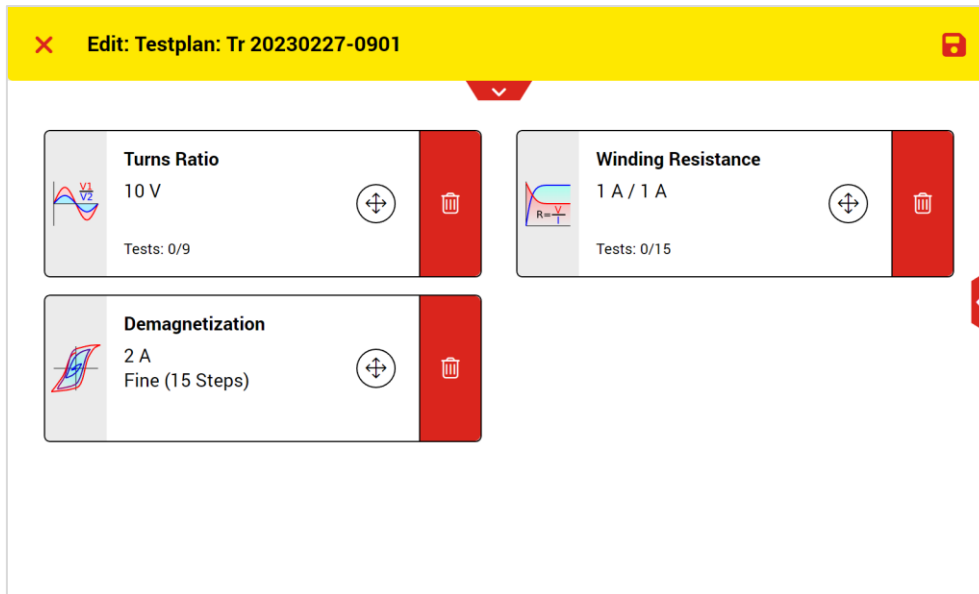

Figure 35: Test Plan edit mode

For the transformers with tertiary winding, for each pair of windings (Pri: Sec & Pri: Ter), there is a separate test plan. To see the test plan for each one, the desired pair of windings must be selected from the drop-down list located above (Figure 36). This drop-down list is only visible when there is a tertiary winding.

Note that when you select another pair of winding, the measurement setup must be changed according to chapter 5.1.

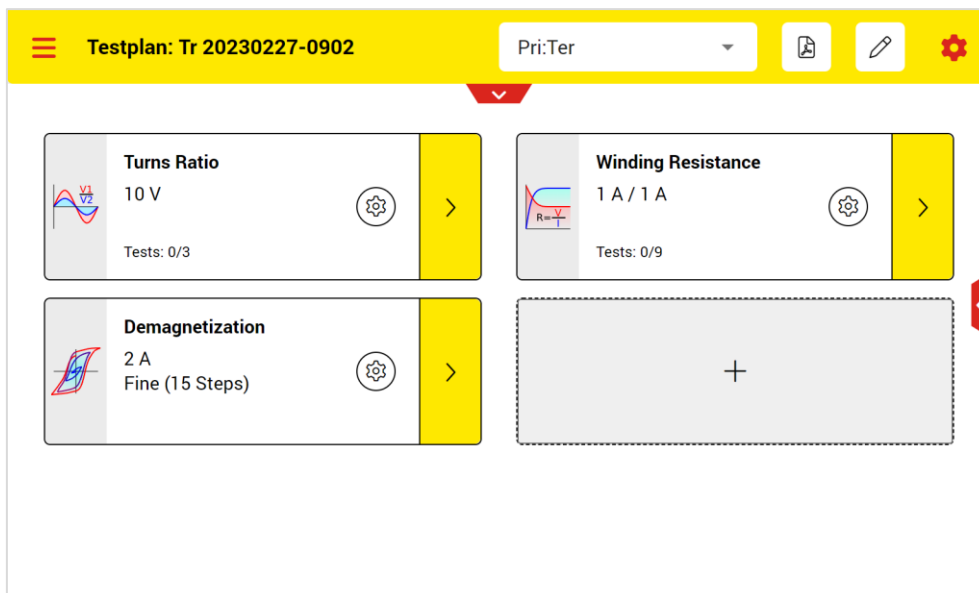

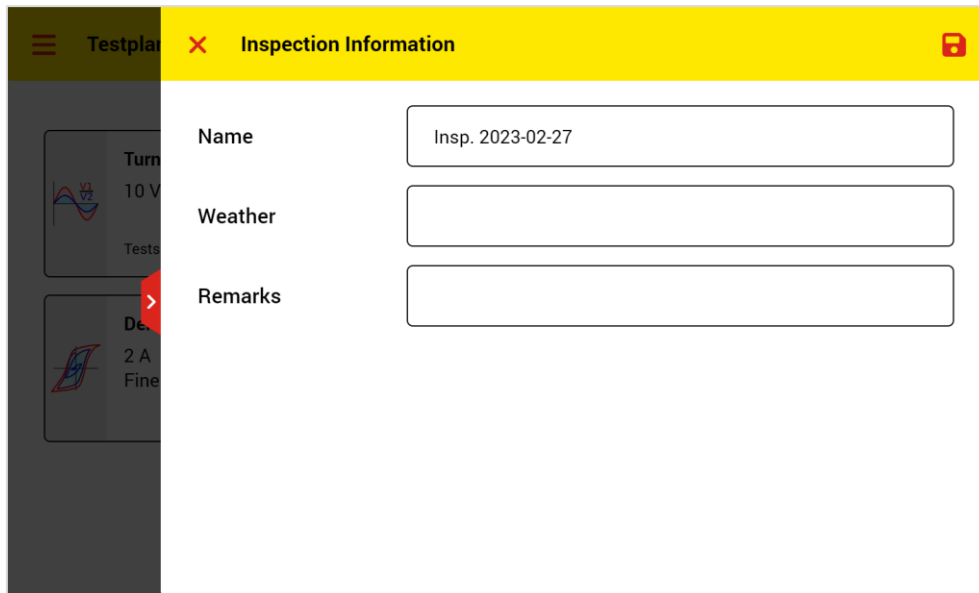

Figure 36: Test plan for Pri: Ter pair, which is selected from the drop-down list located above.

By tapping the setting icon on the top , you can open the Inspection Information (Figure 37). Here it is possible to edit the inspection name, enter the weather condition and write additional notes like the reason for the inspection as remarks for later references.



The screenshot shows a mobile application interface. At the top, there is a yellow header bar with the text "Inspection Information" and a red close button on the left and a red save icon on the right. Below the header, there are three input fields. The first field is labeled "Name" and contains the text "Insp. 2023-02-27". The second field is labeled "Weather" and is empty. The third field is labeled "Remarks" and is empty. On the left side of the screen, there is a dark sidebar with a menu icon and some test parameters like "Turn 10 V" and "2 A Fine".

Figure 37: Inspection information

10 Measurements

10.1 Turns Ratio

Figure 38 shows the turns ratio measurement view and following that each part is explained.

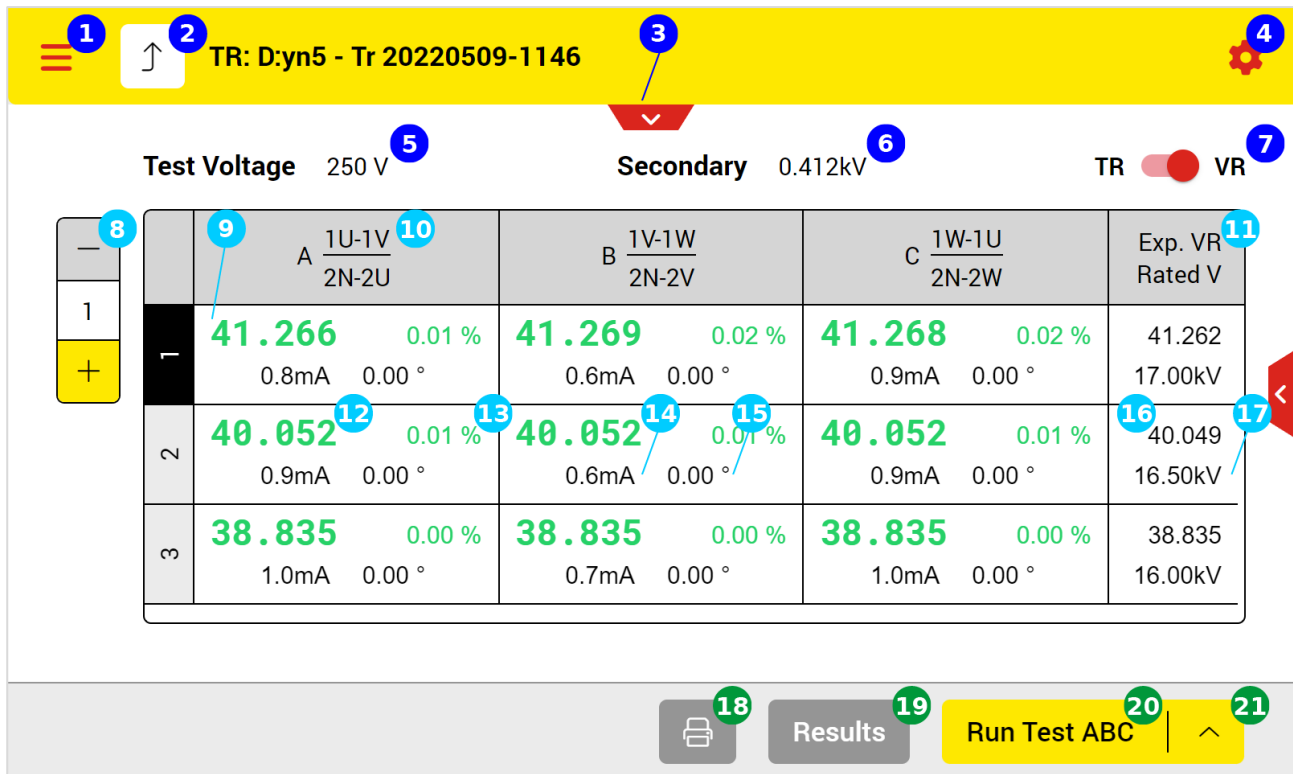

Figure 38: Turns Ratio measurement view

- 1 Open the main menu
- 2 Back to the test plan page
- 3 Open test object quick access
- 4 Test settings (Please see chapter 10.1.2)
- 5 The selected test voltage that applies on the primary side during the measurement
- 6 The secondary side rated voltage
- 7 Change between voltage or turns ratios
- 8 The actual tap position of the selected view mode and to change it
- 9 Tap positions of the selected view mode. The actual is with the dark background
- 10 The phase and the corresponding connections which be used automatically by the instrument to test each phase
- 11 Expected turns or voltage ratio
- 12 The measured turns or voltage ratio; green means that the relative error is less than the error limit and the test is Passed
- 13 The calculated relative error in %; green means that the relative error is less than the error limit and the test is Passed

- 14 The test current in mA
- 15 The measured angle between the applied voltage and the transformed voltage
- 16 The rated turns or voltage ratio
- 17 The rated voltage of each tap position
- 18 Print the selected tap position results by using the thermal printer
- 19 Open the detailed results in table view or graphs
- 20 Start test button
- 21 Test mode to select which phase to test (A, B, C, ABC, Run Test Taps)

The measurement view during the test is shown in Figure 39 and then the important parts are explained.

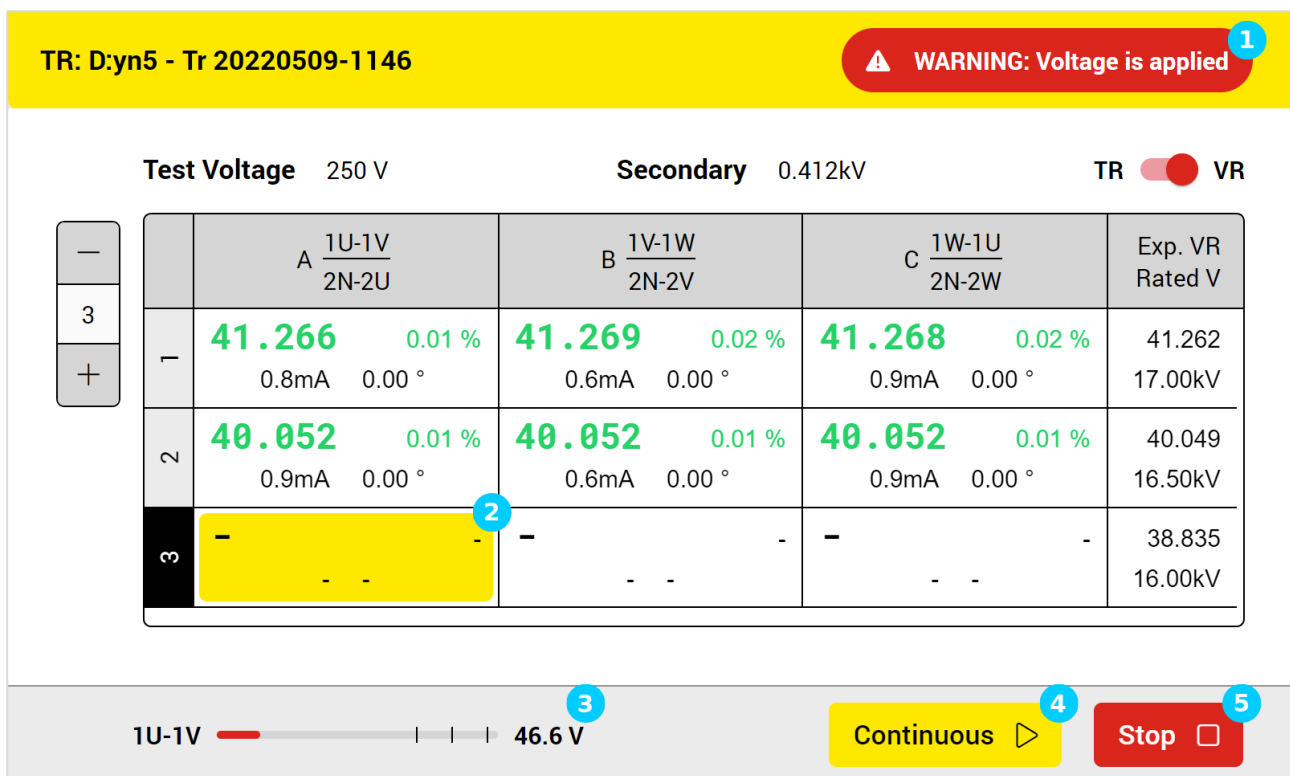

Figure 39: Turns Ratio measurement view during the test

- 1 The warning symbol shows that it is not safe to touch the cables and test clamps
- 2 The highlighted cell shows which phase and tap are currently under the test
- 3 The output voltage bar shows what is the actual value of output voltage and which terminals are used to apply the voltage
- 4 By tapping the continuous button, the test mode changes from single-measurement to continuous mode and the test will not stop automatically. The instrument keeps performing the test on the phase under the test until the user action
- 5 The stop button can be used to stop the test. Please note that it takes time to stop the test

10.1.1 Table view modes

When both primary side and non-primary side of transformer windings have tap positions, it is not easy to show all measurements for all tap combinations in one table. Hence, to show the measurements easier, there are two table view modes. The first one is the primary table view mode. In this mode, for each tap position on the non-primary side, there is a measurement table consisting all primary tap positions. The other view mode is the non-primary table view mode. In this mode, for each tap position on the primary side, there is a measurement table which includes all non-primary tap positions.

As an example, assume that there is transformer with 5 taps (1 to 5) on the primary side, and 33 taps (16R to 16L) on the secondary side. Figure 40 shows the primary view mode. In this mode for each of the secondary taps, there is table with 5 primary taps (33 tables, each 5 taps). The secondary selected tap is shown on the top and it is possible to change it.

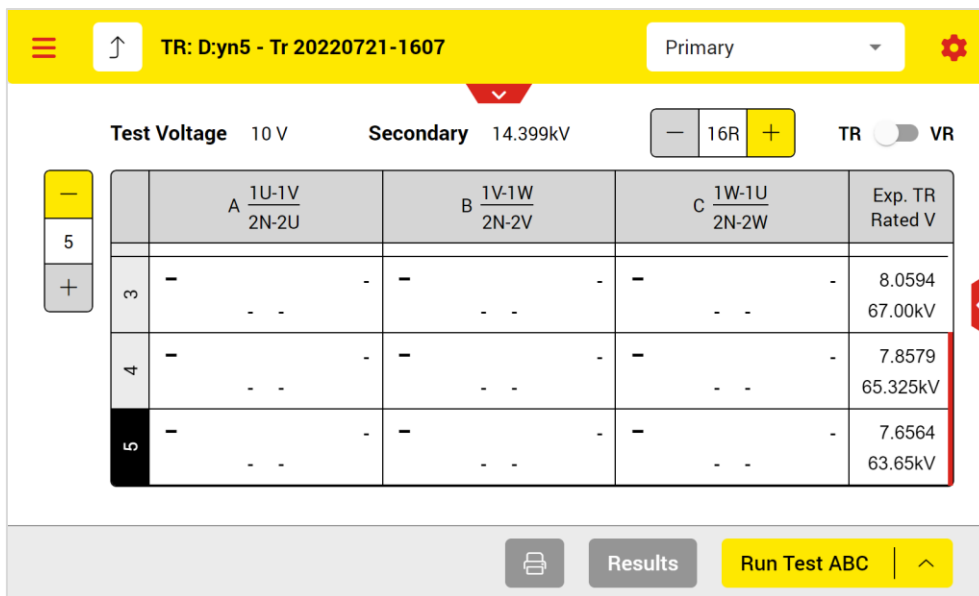

Figure 40: Turns ratio primary view mode

Figure 41 shows on the other hand the secondary view mode. This time for each of the primary taps, there is table with 33 secondary taps (5 tables, each 33 taps). The primary selected tap is also shown on the top and it is possible to change it.

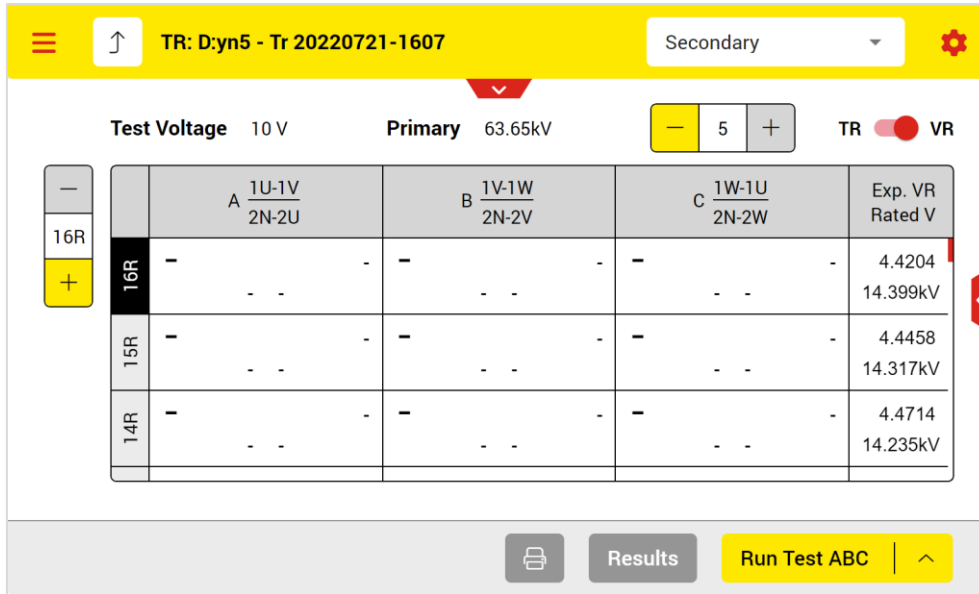

Figure 41: Turns ratio secondary view mode

10.1.2 Turns ratio settings

In Figure 42 the turns ratio setting can be seen. The test voltage can be selected from 10VAC, 40VAC, 100VAC or 250VAC. You can also add user defined test voltages to this list by tapping on the + button. The user defined voltage can be any voltages between 10VAC and 250VAC.

The maximum acceptable ratio error can also be adjusted by editing the Max Error field. The default value according to standards is 0.5%.

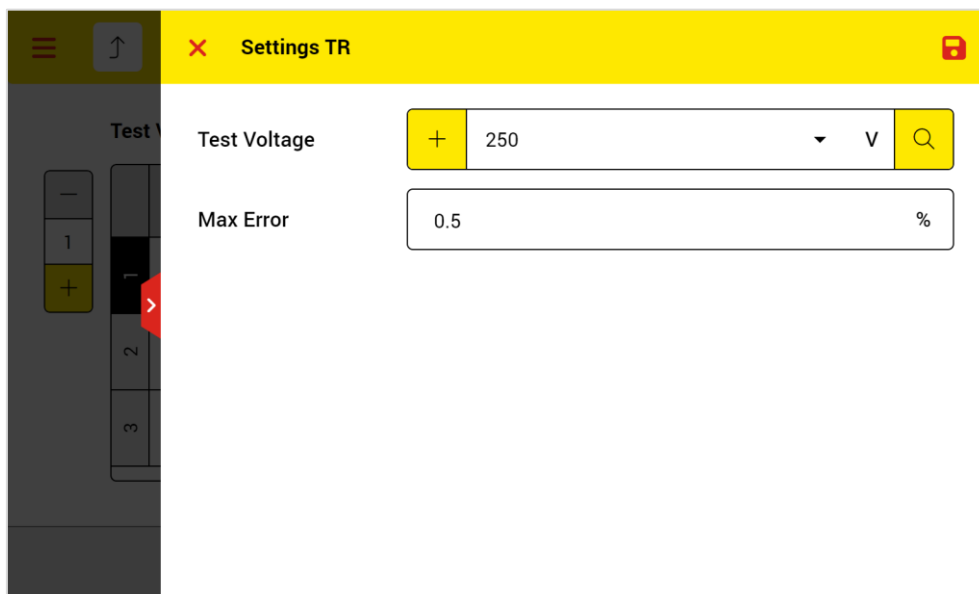

Figure 42: Turns ratio settings



Auto Detect Voltage

It is also possible to find out what is the suitable test voltage for a specific test object. Just tap the search icon, and run detection in the Auto detect voltage window (Figure 43).

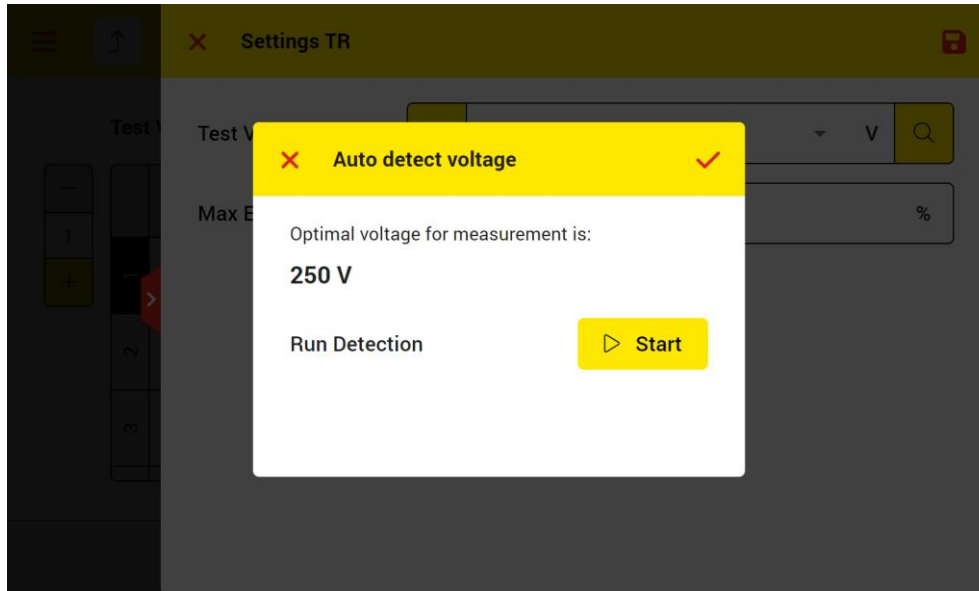

Figure 43: Turns ratio suitable test voltage auto detection

10.1.3 Turns Ratio Results View

By tapping the Results button in the turns ratio measurement view, the result view will be opened. Result view includes graphs and table. Figure 44 shows the turns ratio graph view. From the drop-down list on top right, it is possible to select various graphs. These are turns ratio, voltage ratio and error graph.

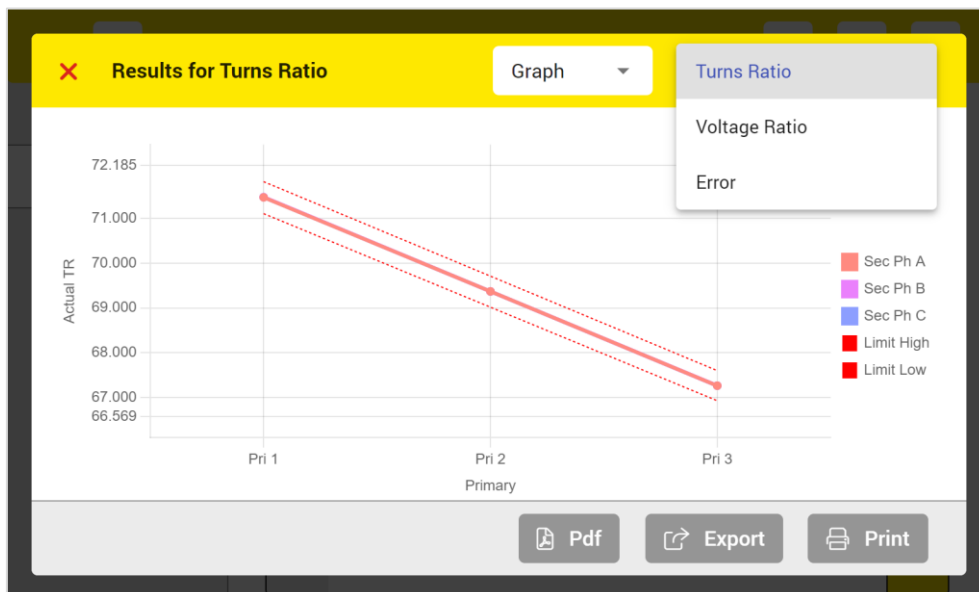
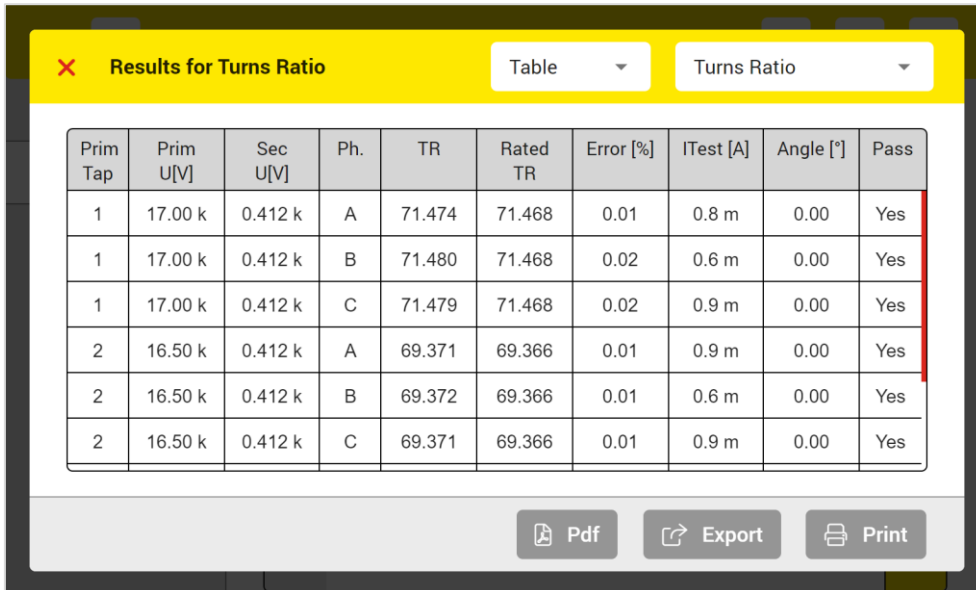

Figure 44: Turn ratio graph results view

Figure 45 shows also the turns ratio table results. By tapping the TR or the Rated TR column header, it is possible to switch between turns ratio and voltage ratio values.



Prim Tap	Prim U[V]	Sec U[V]	Ph.	TR	Rated TR	Error [%]	ITest [A]	Angle [°]	Pass
1	17.00 k	0.412 k	A	71.474	71.468	0.01	0.8 m	0.00	Yes
1	17.00 k	0.412 k	B	71.480	71.468	0.02	0.6 m	0.00	Yes
1	17.00 k	0.412 k	C	71.479	71.468	0.02	0.9 m	0.00	Yes
2	16.50 k	0.412 k	A	69.371	69.366	0.01	0.9 m	0.00	Yes
2	16.50 k	0.412 k	B	69.372	69.366	0.01	0.6 m	0.00	Yes
2	16.50 k	0.412 k	C	69.371	69.366	0.01	0.9 m	0.00	Yes

Figure 45: Turns ratio table results view

10.2 Winding Resistance

Figure 46 shows the measurement view of the primary winding resistance test and following that each part is explained.

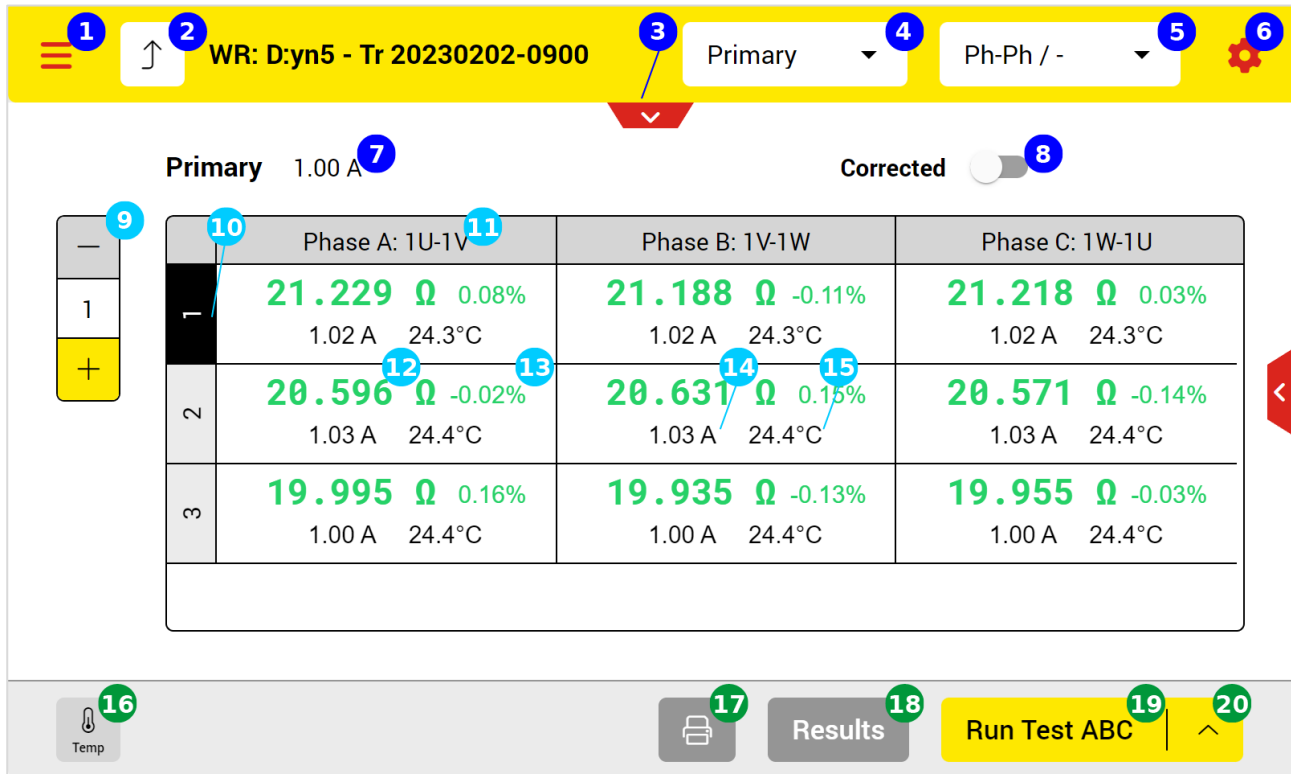

Figure 46: Winding resistance measurement view

- 1 Open the main menu
- 2 Back to the test plan page
- 3 Open test object quick access
- 4 Select the transformer's side to test or to select dual supply mode
- 5 To select test phase to phase or phase to neutral measurement when possible
- 6 Test settings
- 7 The selected current that injects into the selected winding side
- 8 To enable or disable the temperature corrected resistance view
- 9 The actual tap position of the selected view side and to change it
- 10 Tap positions of selected winding side. The actual is with the dark background
- 11 The phase and the corresponding connections which be used automatically by the instrument to test each phase
- 12 The measured winding resistance (temperature corrected or not corrected depending on selection)
- 13 The deviation value from the 3 phases average; green means the deviation is less than the limit and the test is Passed. See chapter 4.2.3 for more information
- 14 The actual test current which was used

- 15 The measured temperature during the measurement or the reference temperature when resistance is corrected
- 16 To see the actual measurement value of each temperature measurement channel
- 17 Print the selected tap position results by using the thermal printer
- 18 Open the detailed results in table view or graphs
- 19 Start test button
- 20 Test mode to select which phase to test (A, B, C, ABC, Run Test Taps)

The winding resistance measurement view during the test is shown in Figure 47 and following it, important parts are explained.

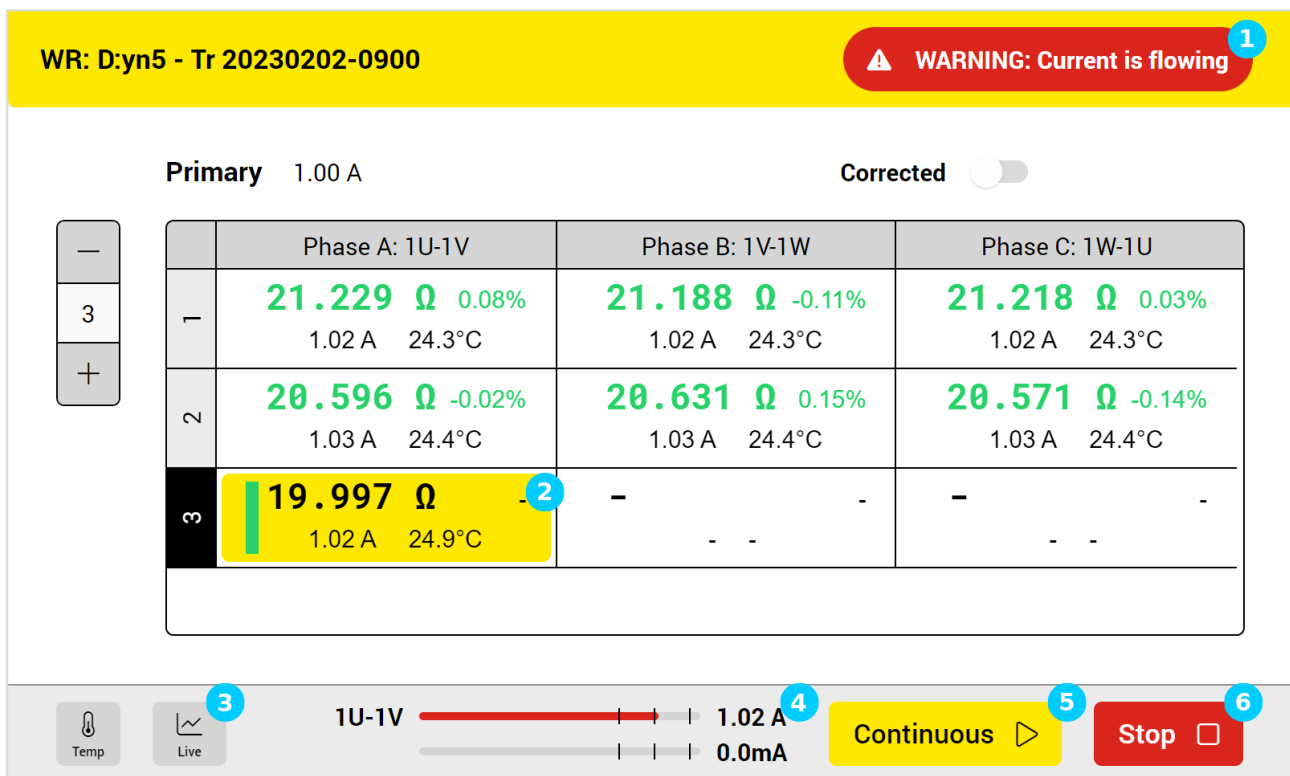

Figure 47: Winding resistance measurement view during the test

- 1 The warning symbol shows that it is not safe to touch the cables and test clamps
- 2 The highlighted cell shows which phase and tap are currently under the test
- 3 Here you can open the live graph to see the live resistance curve over the time (Figure 49)
- 4 The output current bars show what is the actual value of output current for each channel and which terminals are used to inject the currents.
- 5 By tapping the continuous button², the test mode changes from single-measurement to continuous mode and the test will not stop automatically. The instrument keeps performing the test on the phase under the test until the user action
- 6 The stop button can be used to stop the test. Please note that it takes time to discharge and stop the test

² When the ambient temperature is above 40°C, Continuous mode winding resistance measurement, specially with maximum output power, must be limited to 30 minutes and before the next measurement a cooldown time of 30 minutes is required.



WARNING!

After measurement stop, it takes time to discharge the test object! Wait until the device mode changes to safe mode before any other action!

When measuring at non-primary side, there is an additional option to decrease the transformer charging time by charging the transformer from the primary winding at the same time. The current will be injected to the primary winding, but no resistance will be measured. You can active or deactivate this option with the button on the top-right (Figure 48).

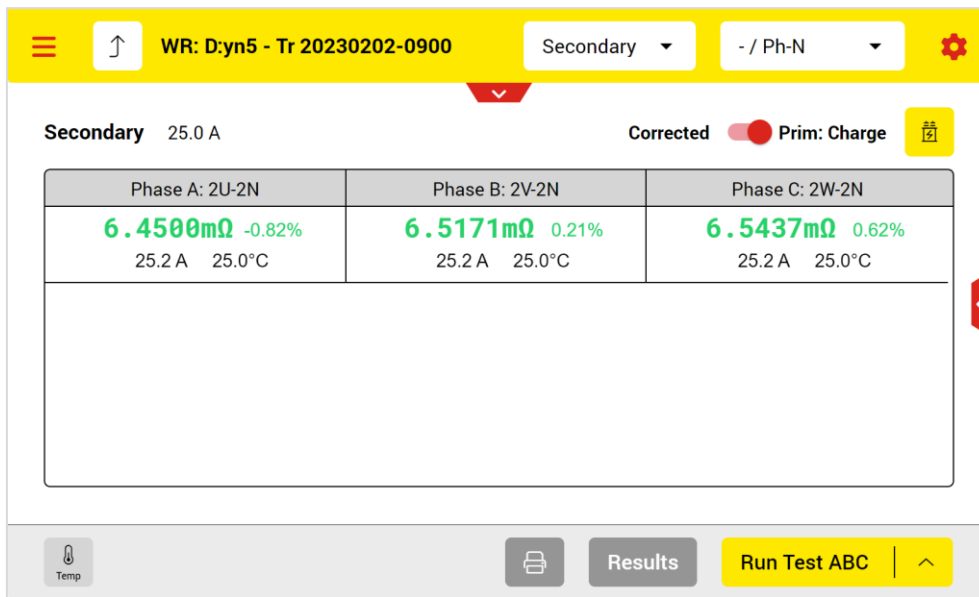

Figure 48: Winding resistance measurement view for the Secondary

Figure 49 is the live graph which shows the live resistance curve over the time.

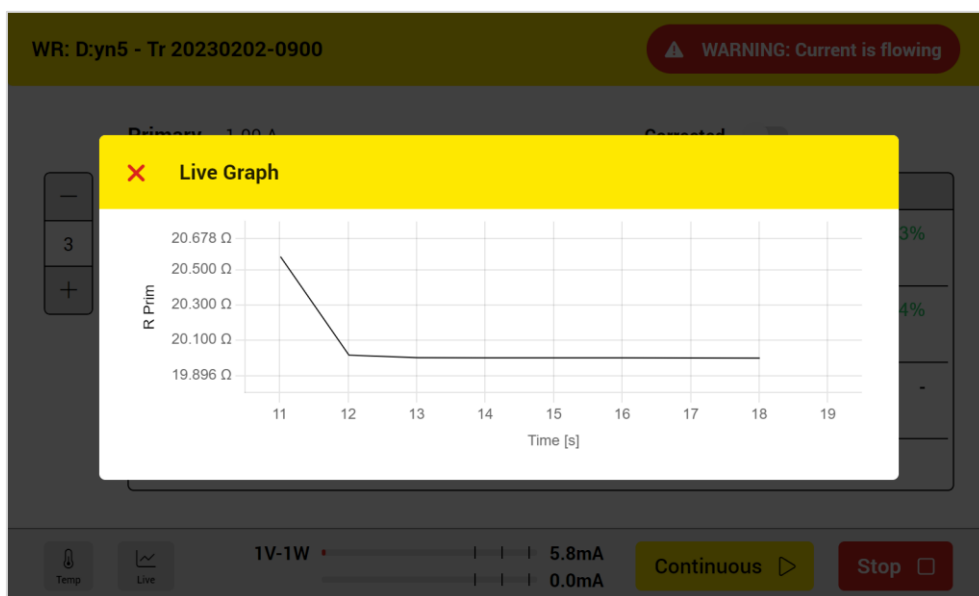

Figure 49: Winding resistance live graph

10.2.1 Dual Supply Winding Resistance

It is also possible to measure the two transformer sides simultaneously by selecting the Dual Supply mode. Figure 50, Shows the winding resistance measurement in dual supply mode and important parts are explained.

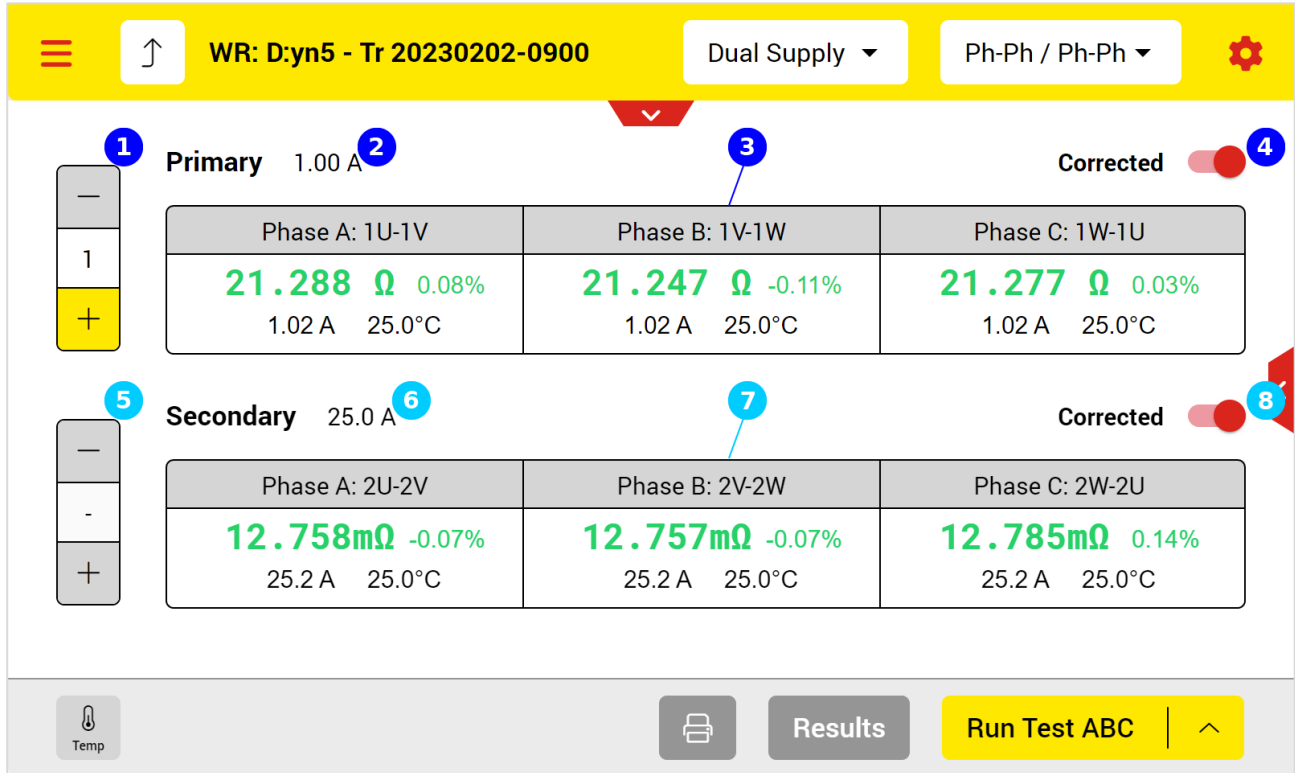

Figure 50: Winding resistance measurement in dual supply mode

- 1 The actual tap position of the primary side (if it contains a tap changer)
- 2 The selected current that injects into the primary winding side
- 3 The measurement table view of the primary side
- 4 To enable or disable the temperature corrected resistances view for primary
- 5 The actual tap position of the non-primary side (if it contains a tap changer)
- 6 The selected current that injects into the non-primary winding side
- 7 The measurement table view of the non-primary side
- 8 To enable or disable the temperature corrected resistances view for non-primary

10.2.2 Winding Resistance Settings

Figure 51 shows the winding resistance main settings.

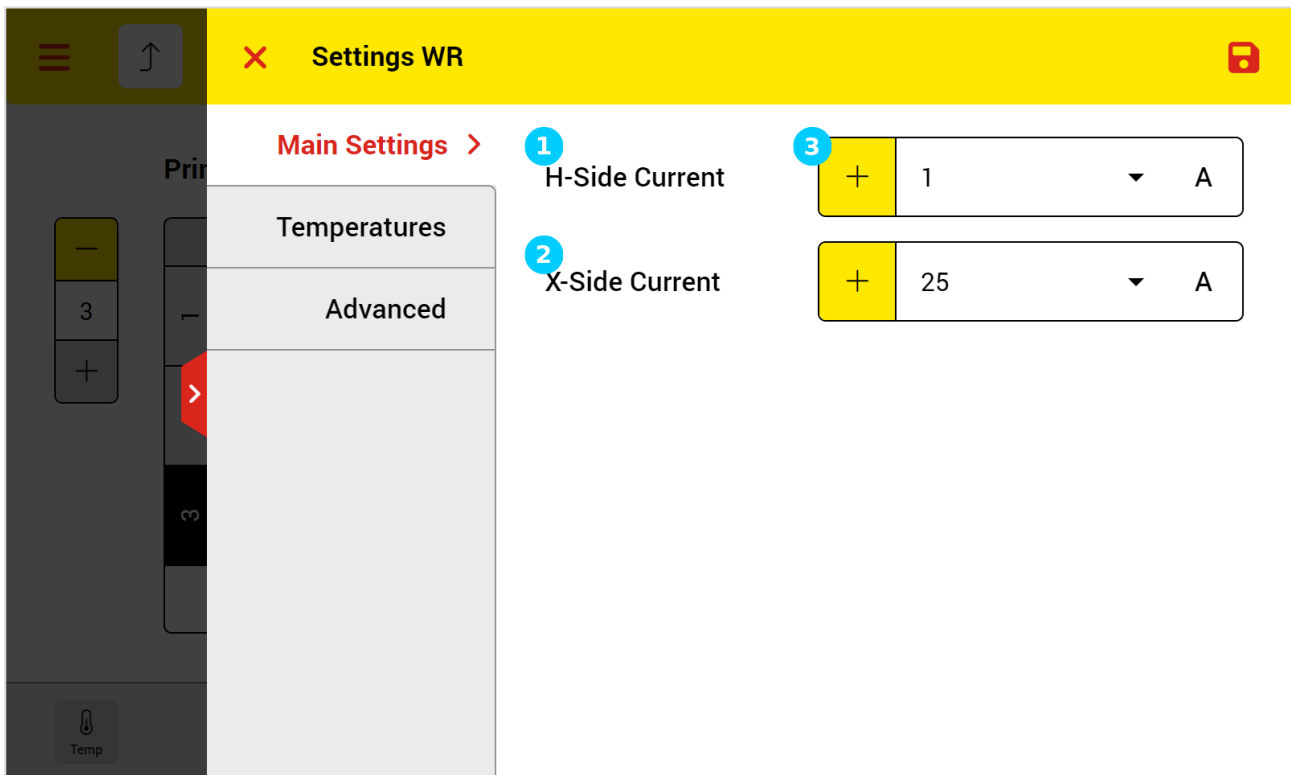

Figure 51: Winding resistance main settings

- 1 To select the H-Side current that injects into the primary winding side
- 2 To select the X-Side current that injects into the non-primary winding side
- 3 By tapping on the plus button, you can add a user-defined test current to the list of the test currents



INFO:

Do not select currents more than 10% of the test object nominal current for each side. Otherwise, current will increase the temperature and hence resistance of the winding.

Figure 52 shows the winding resistance temperature settings.

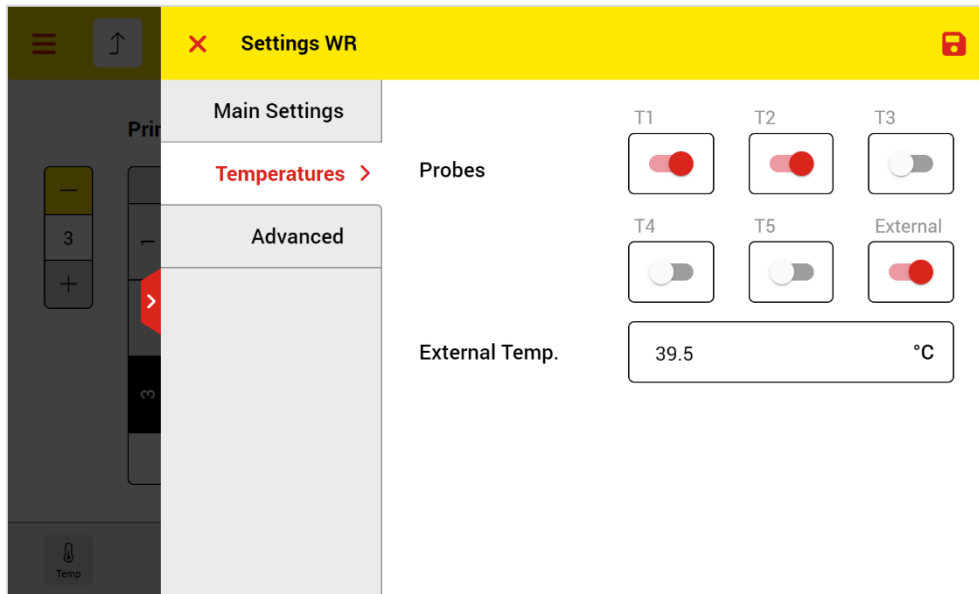

Figure 52: Winding resistance temperatures settings

In temperature settings, it is possible to enable each of the 5 temperature channels to record. When there is an external temperature probe, the External switch should be enabled. The reading value must be also entered manually.

The mini-ATOS use the average of all temperature values for the temperature correction.

In the actual temperature window (Figure 53) which you can open from the measuring screen, you can see the actual temperature values. Here T1 is plugged-in and also activated in the setting. T2 is activated but not plugged-in. In this case, the mini-ATOS shows an error message after starting the measurement. And T3 is not activated but plugged in. Please note that the average value is missing because of T2.

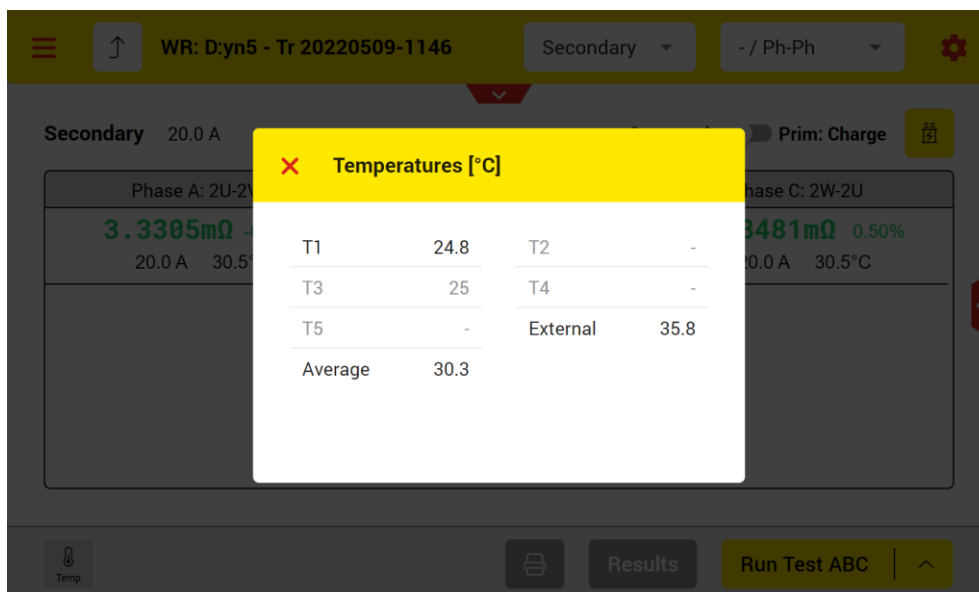

Figure 53: Actual Temperature values

Figure 54 shows the winding resistance advanced settings.

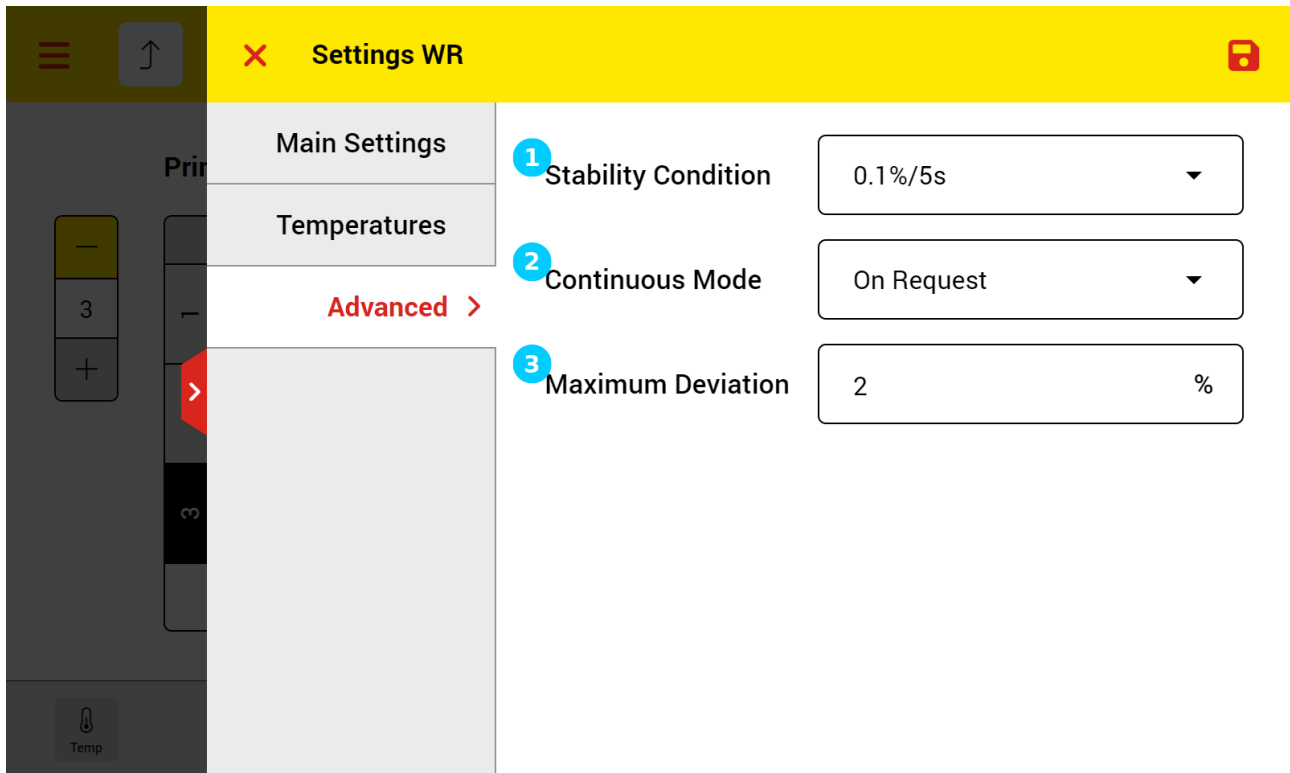

Figure 54: Winding resistance advanced settings

- 1 The stability condition is a reference for the device to decide if the resistance value during a measurement is considered stable or not. For example, 0.1%/5s means that if the resistance fluctuations keep less than 0.1% of the average value continuously for more than 5 seconds, it will be considered stable
- 2 When continuous mode is “On Request”, one can activate the continuous mode only by tapping on the continuous button. When mode is “Always”, the continuous mode is always activated automatically.
- 3 The maximum acceptable deviation value. Please see chapter 4.2.3 for more information

10.2.3 Winding Resistance Result View

By tapping the Results button in the measurement view, the result view will be opened. Result view includes graphs and table. Figure 55 shows the Primary (Ph-Ph) winding resistance graph view. From the drop-down list on top right, it is possible to select also other graphs.



Figure 55: Winding resistance graph results view

Figure 56 shows also the Primary (Ph-Ph) table results. By tapping the DevCorr column header, it is possible to switch between deviation for measured values or temperature corrected values.

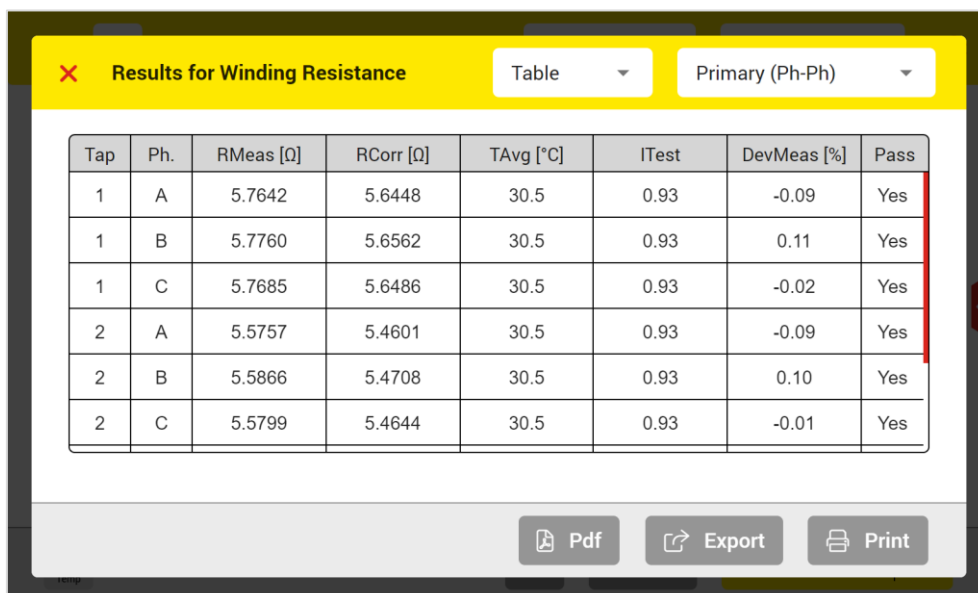

Tap	Ph.	RMeas [Ω]	RCorr [Ω]	TAvg [°C]	ITest	DevMeas [%]	Pass
1	A	5.7642	5.6448	30.5	0.93	-0.09	Yes
1	B	5.7760	5.6562	30.5	0.93	0.11	Yes
1	C	5.7685	5.6486	30.5	0.93	-0.02	Yes
2	A	5.5757	5.4601	30.5	0.93	-0.09	Yes
2	B	5.5866	5.4708	30.5	0.93	0.10	Yes
2	C	5.5799	5.4644	30.5	0.93	-0.01	Yes

Figure 56: Winding resistance table results view

10.2.4 Auto Transformer Winding Resistance

Mini-ATOS has special winding resistance measurement for Auto Transformers. The parameters and method of measurements are summarized in Table 8. The method of measurements in Table 8 are for phase A of a star-null auto transformer.

Table 8: The autotransformer winding resistance parameters and measurement methods

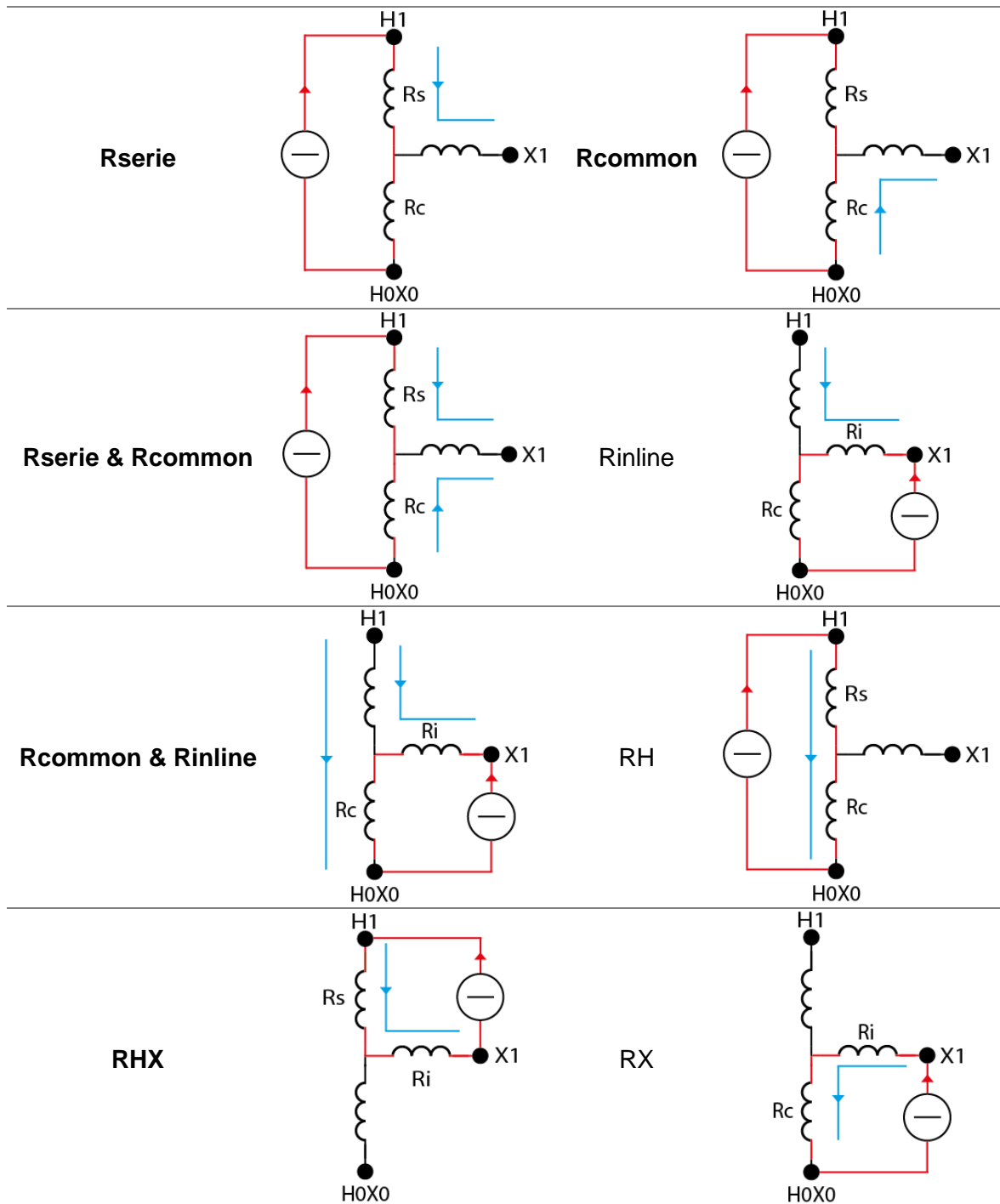

The measurement view of winding resistance measurement for Auto Transformer is shown in Figure 57 and following that each part is explained.

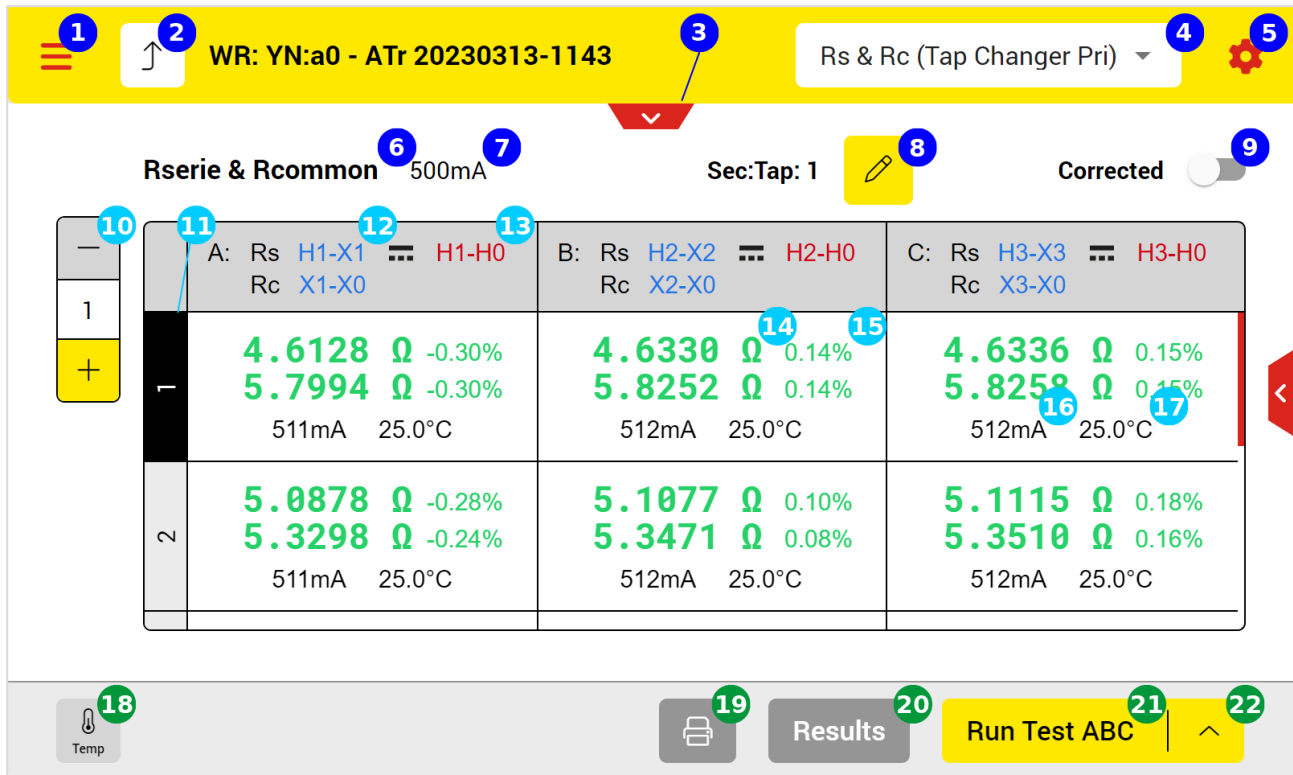

Figure 57: Winding resistance measurement view for an auto transformer

- 1 Open the main menu
- 2 Back to the test plan page
- 3 Open test object quick access
- 4 Select the measuring parameter which is selected in measurement settings
- 5 Test settings
- 6 The measuring parameter or parameters
- 7 The selected current which will be used for the measurement
- 8 To select the other tap changer position when available
- 9 To enable or disable the temperature corrected resistance view
- 10 The actual tap position of the selected view side and to change it
- 11 Tap positions of selected winding side. The actual is with the dark background
- 12 The phase and the corresponding connections which be used automatically by the instrument to measure each parameter
- 13 The corresponding connections which be used automatically by the instrument to inject the current
- 14 The measured winding resistances for each parameter (temperature corrected or not corrected depending on selection)
- 15 The deviation values of each parameter from the 3 phases average; green means the deviation is less than the limit and the test is Passed. See chapter 4.2.3 for more information

- 16 The actual test current which was used
- 17 The measured temperature during the measurement or the reference temperature when resistance is corrected
- 18 To see the actual measurement value of each temperature measurement channel
- 19 Print the selected tap position results by using the thermal printer
- 20 Open the detailed results in table view or graphs
- 21 Start test button
- 22 Test mode to select which phase to test (A, B, C, ABC, Run Test Taps)

The Measurement main settings are shown in Figure 58. The other settings are the same with the winding resistance measurement settings. For temperature settings and the advanced settings please refer to chapter 10.2.2.

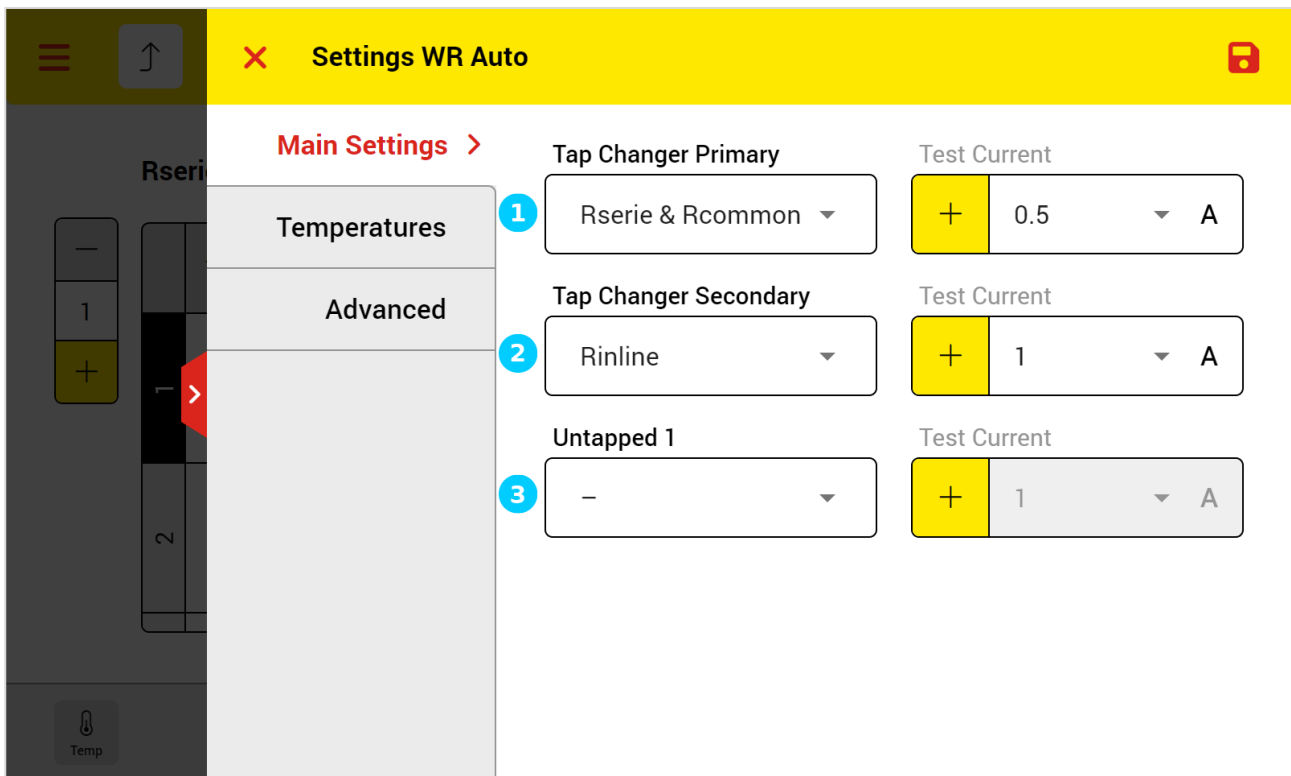

Figure 58:Auto transformer winding resistance main settings

- 1 When there is a tap changer on the primary side, you can select which parameter or parameters to be measured as a function of primary tap positions. For this measurement you can select the test current
- 2 When there is also a tap changer on the secondary side, you can select which parameter or parameters to be measured as a function of the secondary tap positions. For this measurement you can select also the test current separately
- 3 Here, you can select which parameter or parameters to be measured not as a function of any tap changer. For this measurement you can also select the desired test current

10.3 Winding Resistance Interval

With interval measurement, it is possible to measure the winding resistance as a function of time. Figure 59 shows the measurement view and following that each part is explained.

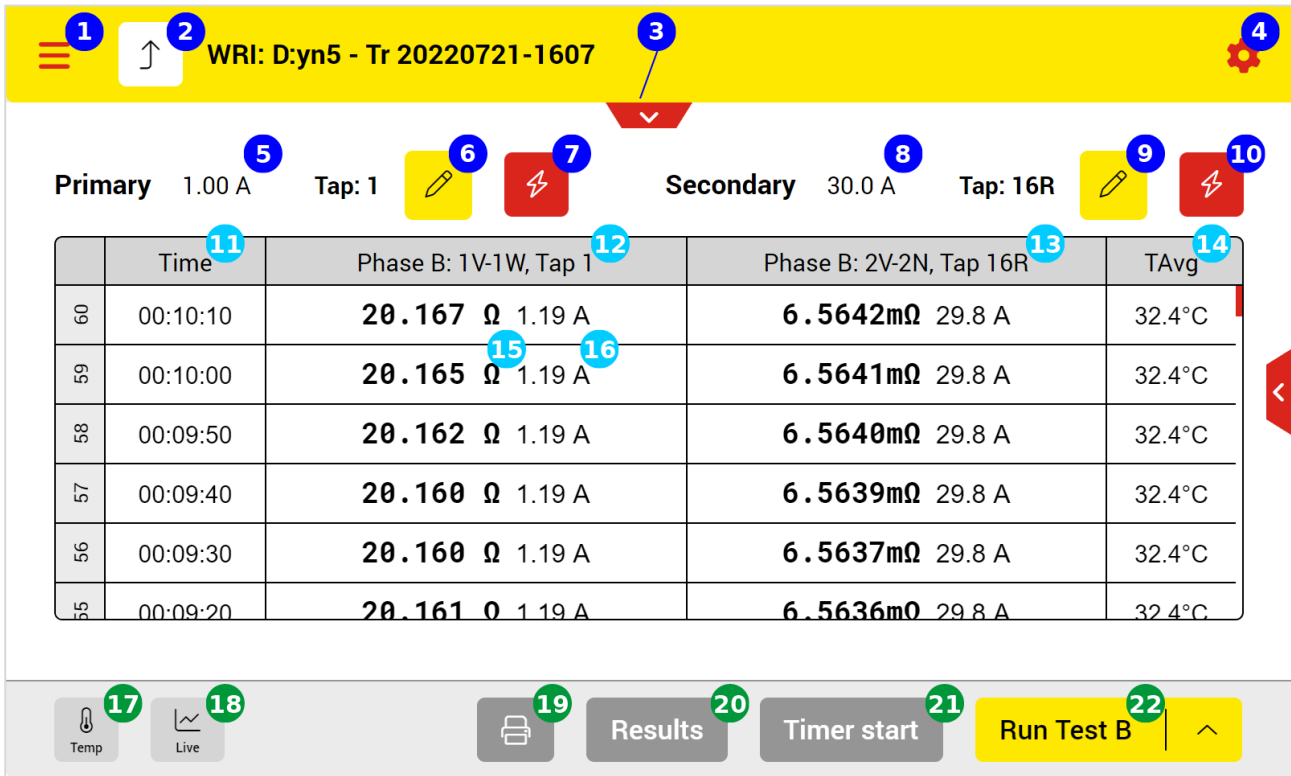

Figure 59: Winding Resistance Interval measurement view

- 1 Open the main menu
- 2 Back to the test plan page
- 3 Open test object quick access
- 4 Test settings
- 5 The selected current that injects into the primary winding side
- 6 The actual tap position of primary side
- 7 To turn On or turn Off the power supply for the primary side. It is also possible to select "Charge" mode. In charge mode, the power supply injects current to the primary side to increase the transformer charging speed. But no resistance will be measured
- 8 The selected current that injects into the Secondary winding side
- 9 The actual tap position of secondary side
- 10 To turn On or turn Off the power supply for the secondary side
- 11 Elapsed time
- 12 The phase and the corresponding connections which be used automatically by the instrument to test each side and also the tap position
- 13 The phase and the corresponding connections which be used automatically by the instrument to test each side and also the tap position

- 14 The average of measured and external temperatures
- 15 The measured resistance
- 16 The actual test current
- 17 To see the actual measurement value of each temperature measurement channel
- 18 To see the resistance curve over the time
- 19 Print results by using the thermal printer
- 20 Detailed results in table view or graphs
- 21 To start the timer separately. When you run the test without starting the timer, the timer will automatically also start
- 22 Start test button

The winding resistance interval measurement view during the test is shown in and following it, important parts are explained.

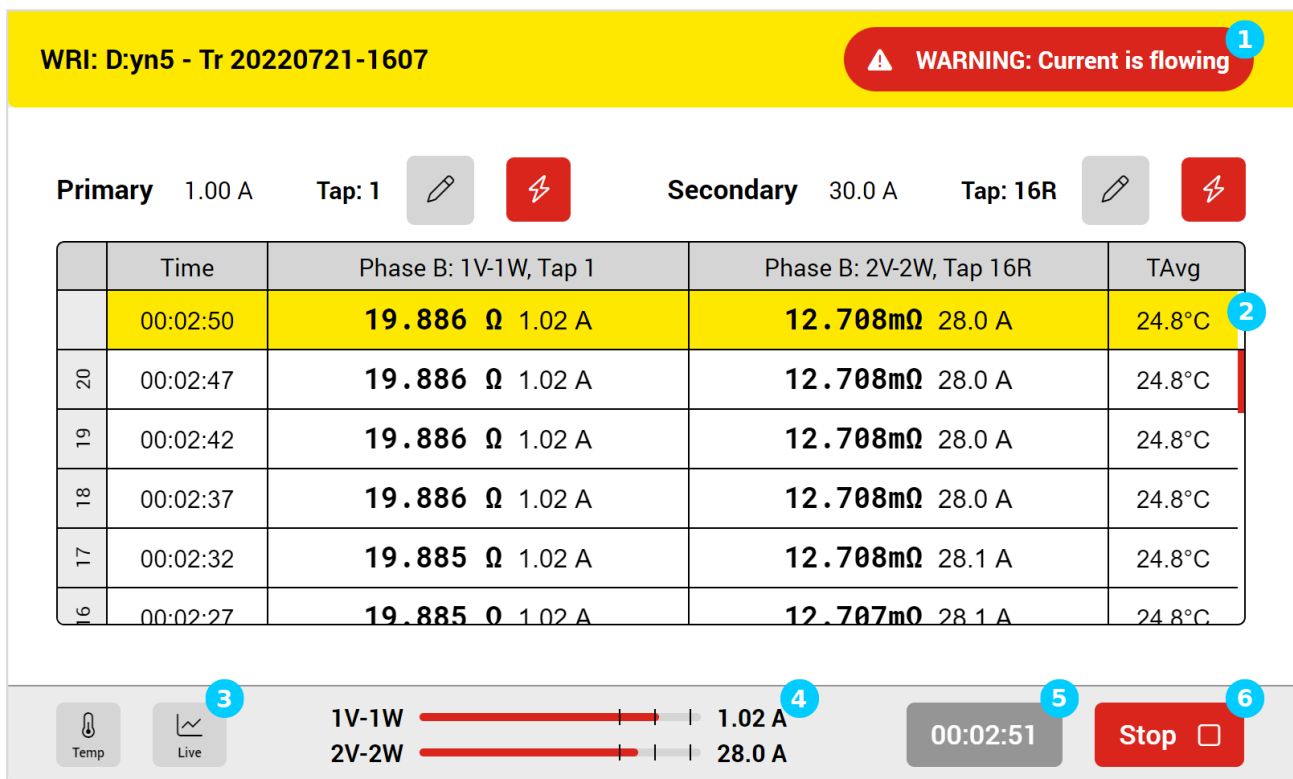

Figure 60: Winding resistance interval measurement view during the test

- 1 The warning symbol shows that it is not safe to touch the cables and test clamps
- 2 The highlighted row shows the actual parameters value
- 3 Here you can open the live graph to see the live resistance curve over the time
- 4 The output current bars show what is the actual value of output current for each channel and which terminals are used to inject the currents
- 5 The actual elapsed time

- The stop button can be used to stop the test. Please note that it takes time to discharge and stop the test



WARNING!

After measurement stop, it takes time to discharge the test object! Wait until the device mode changes to safe mode before any other action!

10.3.1 Winding Resistance Interval Settings

Figure 61 shows the winding resistance interval main settings.

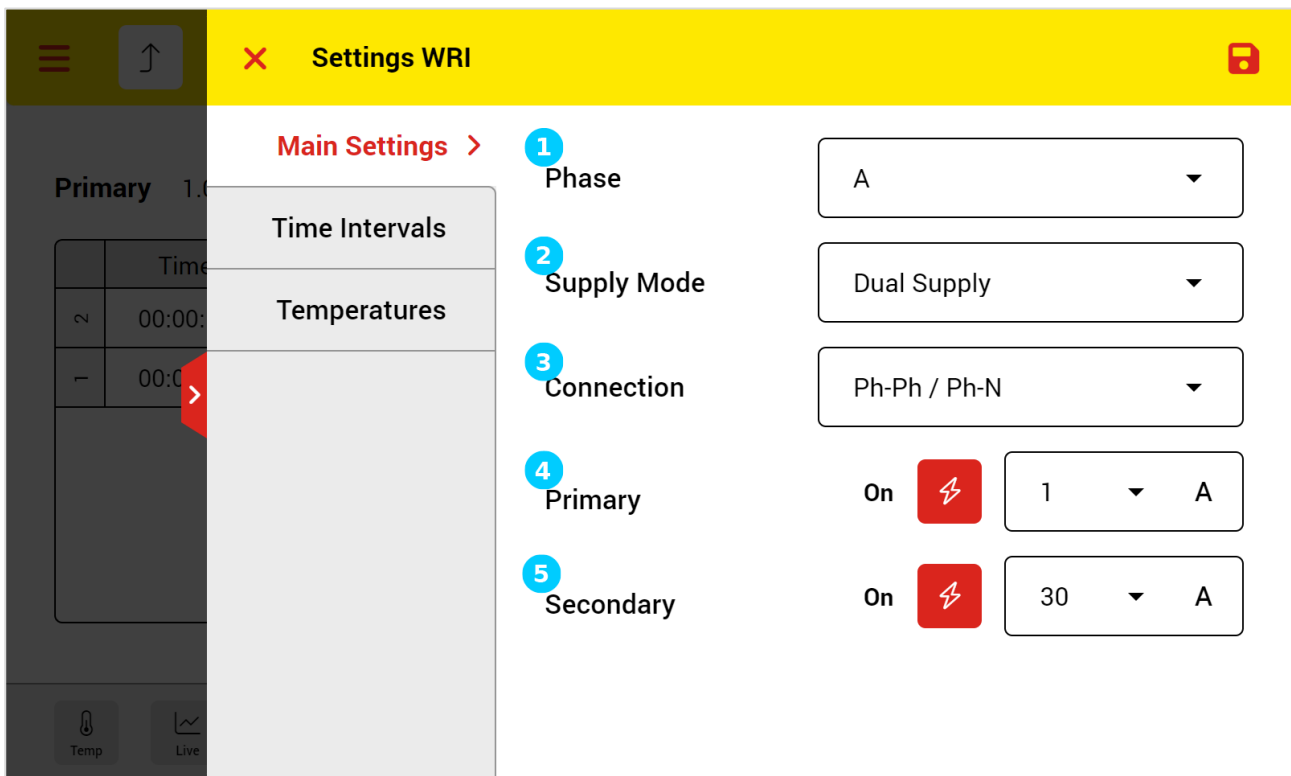

Figure 61: Winding resistance interval main settings

- To select which phase to test
- To measure both Primary and Secondary simultaneously with two power supply or to select which side to measure with one power supply
- To select test phase to phase or phase to neutral measurement when possible
- To select the current that injects into the primary winding side and also to turn On or turn Off the power supply for the primary side. It is also possible to select "Charge" mode. In charge mode, the power supply injects current to the primary side to increase the transformer charging speed. But no resistance will be measured
- To select the current that injects into the secondary winding side and also to turn On or turn Off the power supply for the secondary side

Figure 62 shows the time intervals settings.

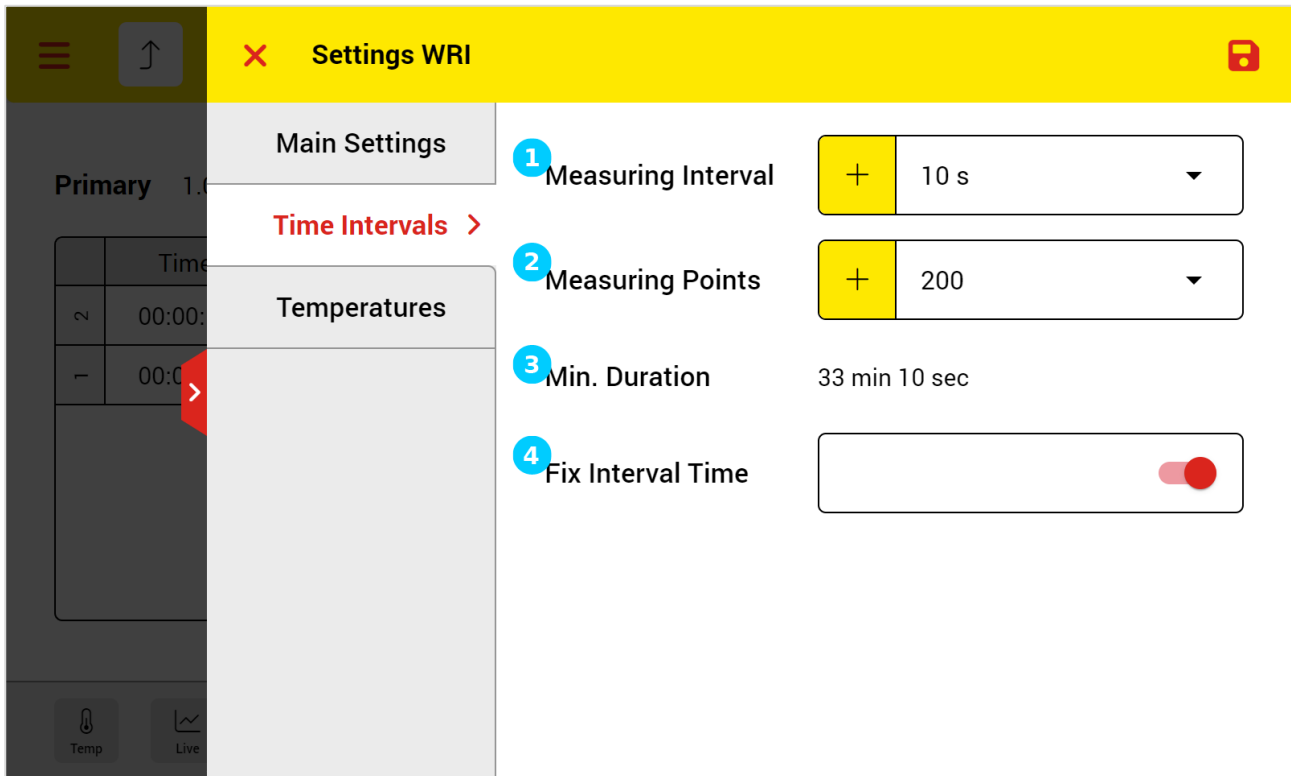

Figure 62: Winding resistance interval, time intervals settings

- 1 To set the time duration between each two measurement points
- 2 To set the number of measuring points
- 3 Total measurement duration which is calculated by timing measuring interval and measuring points
- 4 To set the interval time from Start Time instead of from the 1st measurement point.
e.g. If the Interval Time is set to 10 seconds and the first measurement is taken at 27 seconds, the system stores results at 27, 37, 47...seconds if fix interval time is not selected. if fix interval time is selected, the results will be taken and stored at 27, 30, 40, 50...seconds

The temperature settings of the winding resistance interval are the same as winding resistance settings. Please see chapter 10.2.2, Temperature settings part, to see the explanation.

10.3.2 Winding Resistance Interval Result View

By tapping the Results button in the measurement view, the result view will be opened. Result view includes graphs and table. Figure 63 shows the Primary winding resistance graph view. From the drop-down list on top right, it is possible to select also other graphs.

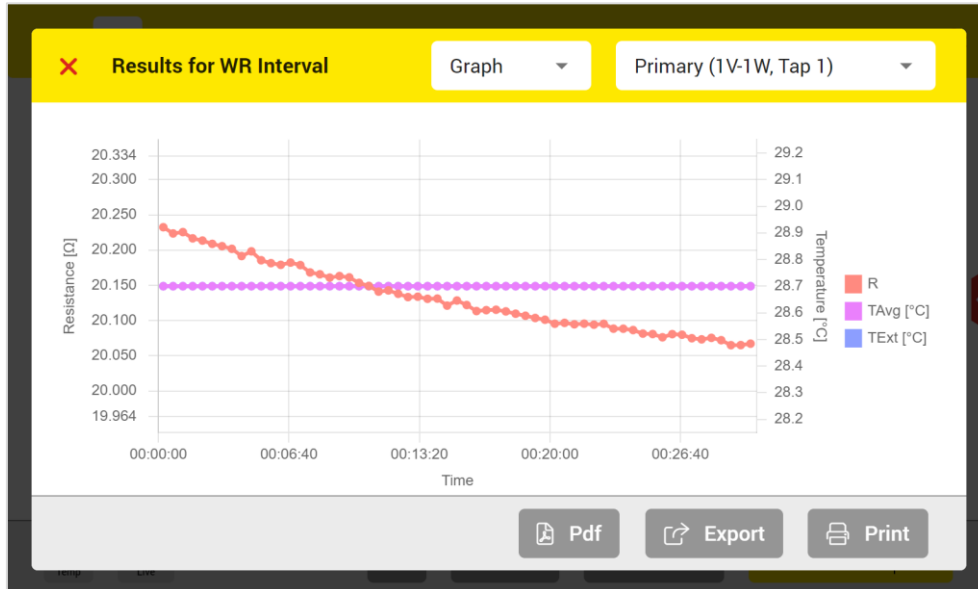
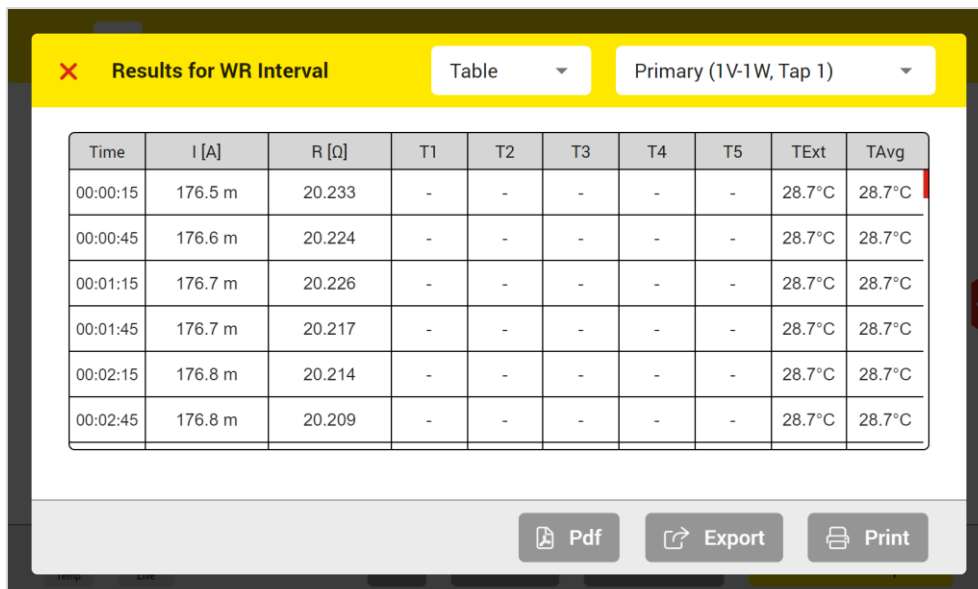

Figure 63: Winding resistance interval graph results view

Figure 64 shows also the Primary table results.



Time	I [A]	R [Ω]	T1	T2	T3	T4	T5	TExt	TAVg
00:00:15	176.5 m	20.233	-	-	-	-	-	28.7°C	28.7°C
00:00:45	176.6 m	20.224	-	-	-	-	-	28.7°C	28.7°C
00:01:15	176.7 m	20.226	-	-	-	-	-	28.7°C	28.7°C
00:01:45	176.7 m	20.217	-	-	-	-	-	28.7°C	28.7°C
00:02:15	176.8 m	20.214	-	-	-	-	-	28.7°C	28.7°C
00:02:45	176.8 m	20.209	-	-	-	-	-	28.7°C	28.7°C

Figure 64: Winding resistance interval table results view

10.4 Demagnetization

Figure 65 shows the demagnetization view and Figure 66 shows the demagnetization view during the test and following each one, the important parts are explained.

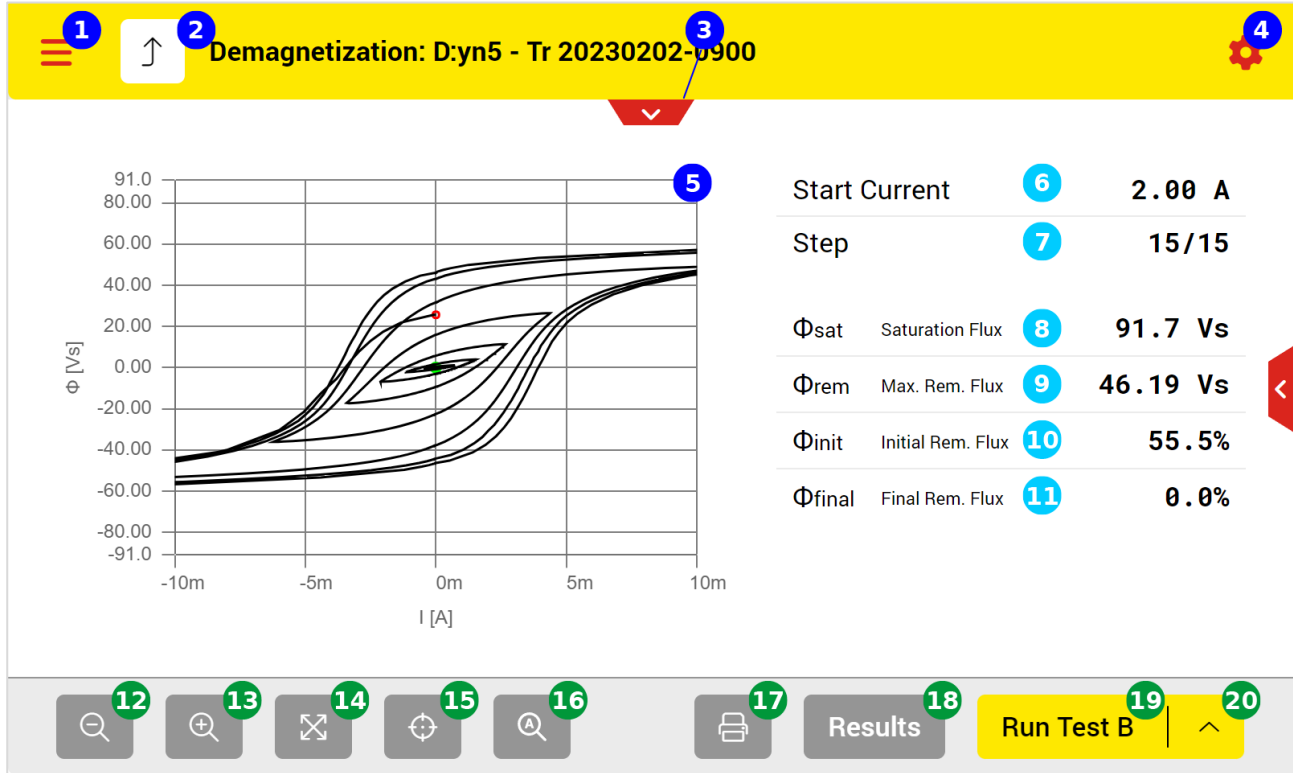

Figure 65: Demagnetization view

- 1 Open the main menu
- 2 Back to the test plan page
- 3 Open test object quick access
- 4 Test settings
- 5 The demagnetization curve (Zoomable with two fingers)
- 6 The adjusted start current that injects into the primary winding
- 7 Number of cycles already performed from all cycles
- 8 The measured saturation flux
- 9 The measured maximum remanence flux
- 10 The measured initial remanence flux in % (as the percentage of the measured maximum remanence flux)
- 11 The measured final remanence flux in % (as the percentage of the measured maximum remanence flux)
- 12 Zoom out
- 13 Zoom in
- 14 Maximize the graph view
- 15 Centre the graph view

- 16 Automatic adaptive graph view
- 17 Print results by using the thermal printer
- 18 Detailed results in table view or graphs
- 19 The button to run the test
- 20 Test mode to select which phase to perform the demagnetization

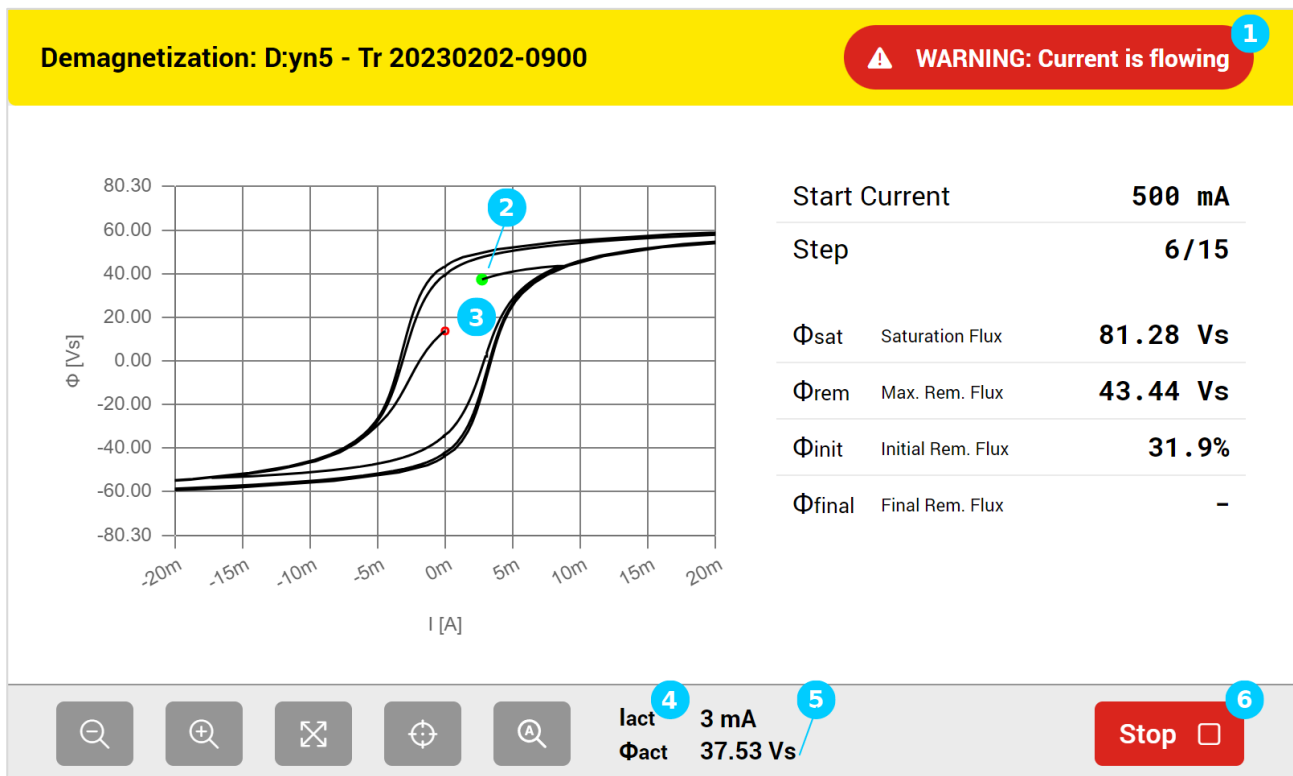

Figure 66: Demagnetization view during the test

- 1 The warning symbol shows that it is not safe to touch the cables and test clamps
- 2 The actual point (the actual flux and the actual current) of the demagnetization curve marked in green
- 3 The first point (initial remanence flux) of the demagnetization curve marked in red
- 4 The actual demagnetization current during the measurement
- 5 The actual flux during the measurement
- 6 The stop button can be used to stop the test. Please note that it takes time to discharge and stop the test



WARNING!

After measurement stop, it takes time to discharge the test object! Wait until the device mode changes to safe mode before any other action!

10.4.1 Demagnetization Settings

Figure 67 shows the demagnetization settings.

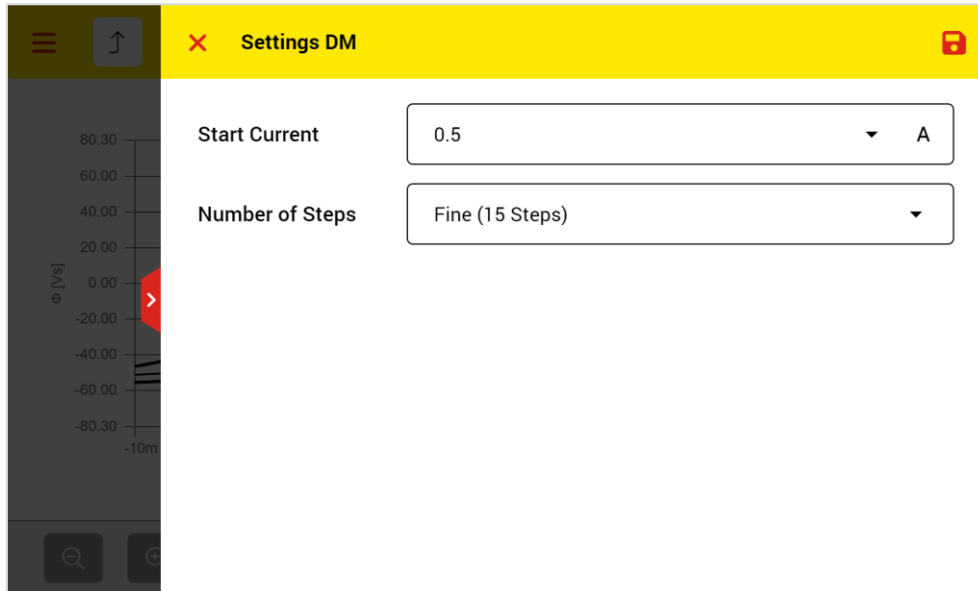

Figure 67: Demagnetization settings

The start current can be selected from 200mA and up to 30A. For currents up to 7.5A, the maximum output voltage is 50VDC (up to 100VDC with the automatic booster). For currents more than 7.5A, the maximum output voltage is 12VDC. If the test object is a large power transformer, the demagnetization will be faster if the currents up to 7.5A will be selected.

The number of steps can be also adjusted from Very Fast (8 Steps) to Very Fine (20 Steps). Normally, to reach a smaller final remanence flux and hence better demagnetization quality, you can select more steps. However, since the mini-ATOS use the Raytech SPP method (See chapter 4.3.1 for more information), the quality of the demagnetization is quite good even when the number of Steps is set to Very Fast (8 Steps).

10.5 Magnetic Balance

Figure 68 shows the measurement view of the Magnetic Balance test and following that each part is explained.

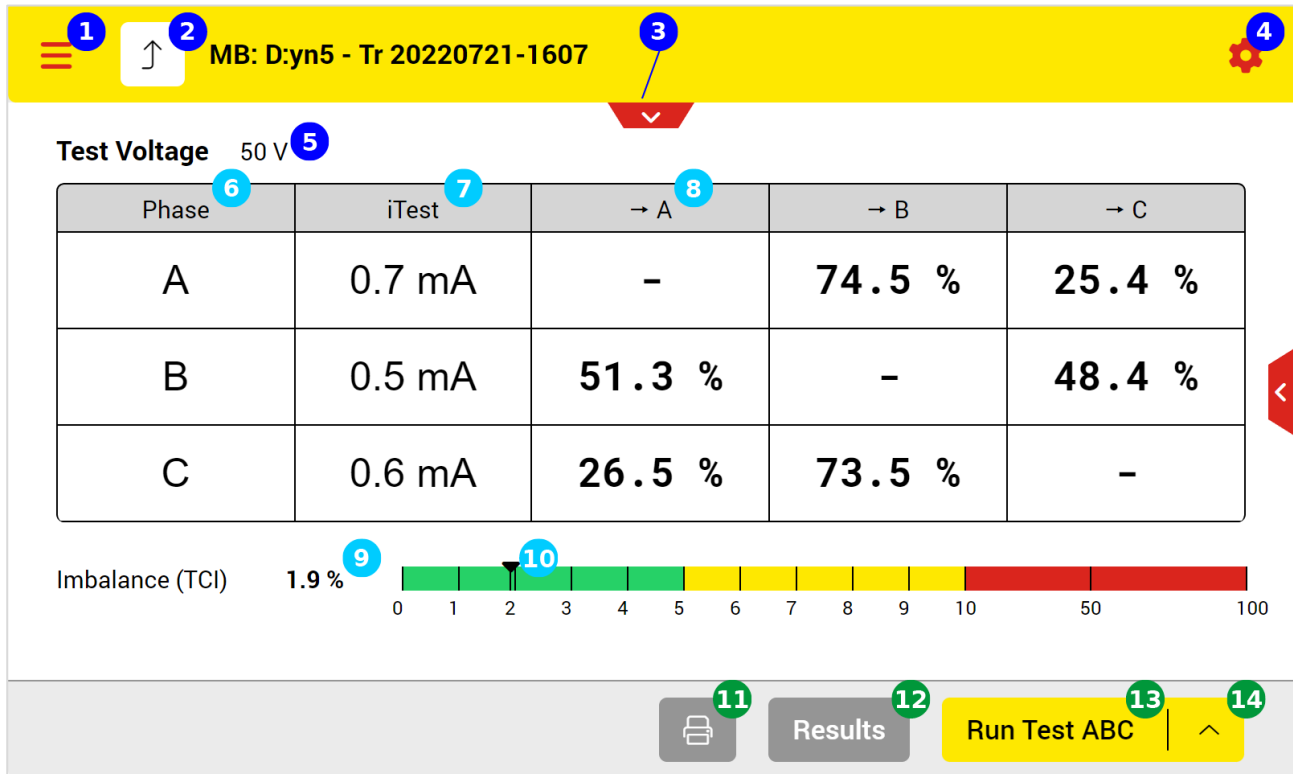

Figure 68: Magnetic Balance measurement view

- 1 Open the main menu
- 2 Back to the test plan page
- 3 Open test object quick access
- 4 Test settings
- 5 The selected test voltage
- 6 The Phase which the voltage applied to
- 7 The output current during the test
- 8 The phase which the voltage measured and the values as a percentage of the applied voltage
- 9 The transformer core imbalance value (see chapter 4.4 for more information)
- 10 Showing the TCI value on a colored bar
- 11 Print the results by using the thermal printer
- 12 Open the detailed results in table view or graphs
- 13 Start test button
- 14 Test mode to select which phase to test (A, B, C, ABC)

Figure 69 shows the magnetic balance test during the measurement.

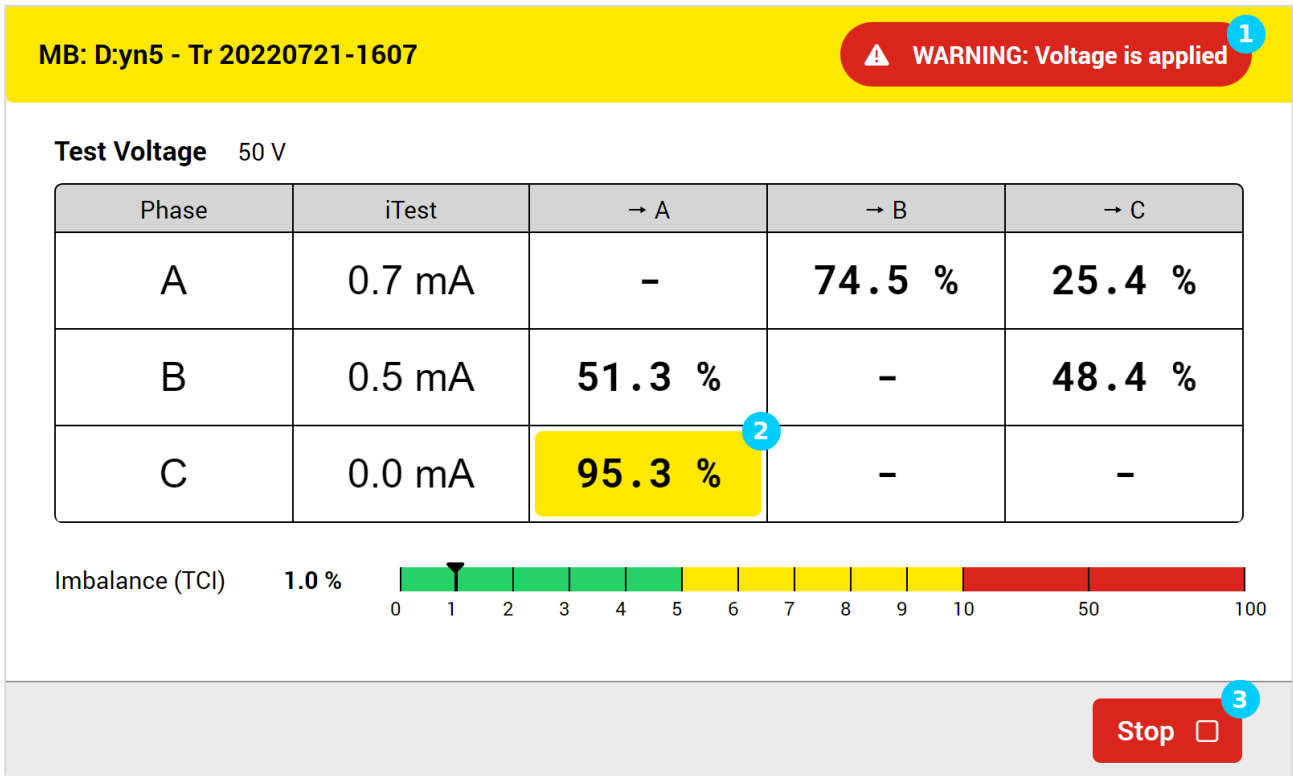

Figure 69: Magnetic balance test during a measurement

- 1 The warning symbol shows that it is not safe to touch the cables and test clamps
- 2 The highlighted cell shows the actual measurement
- 3 The stop button can be used to stop the test. Please note that it takes time to stop the test

10.5.1 Magnetic Balance Settings

Figure 70 represents the magnetic balance measurement settings.

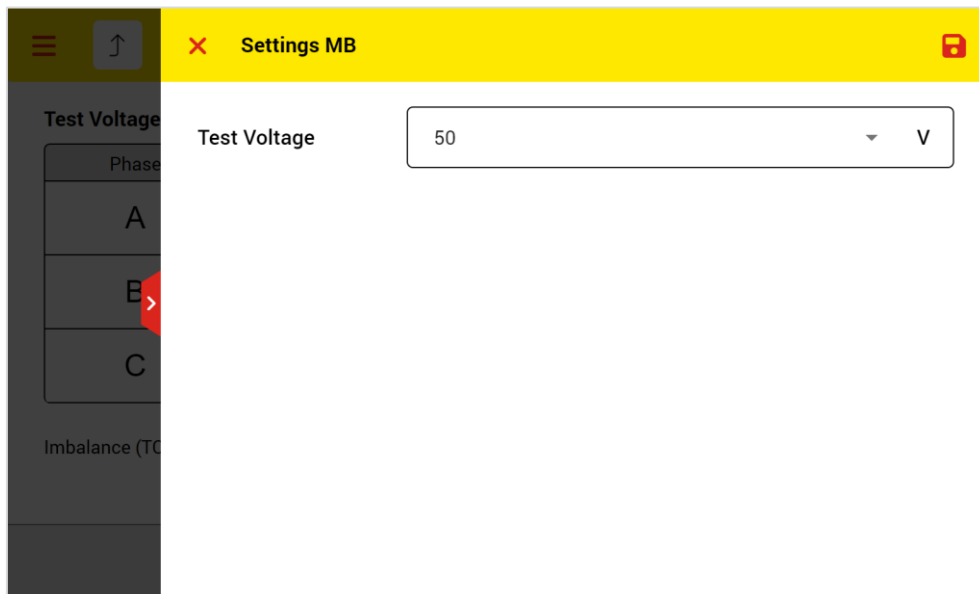

Figure 70: Magnetic balance measurement settings

For magnetic balance, the applying voltage can be selected up to 50VAC. Please note that the test voltage frequency is at 10Hz.

10.5.2 Magnetic Balance Result View

By tapping the Results button in the measurement view, the result view will be opened. Result view includes graphs and table. Figure 71 shows the graph view.

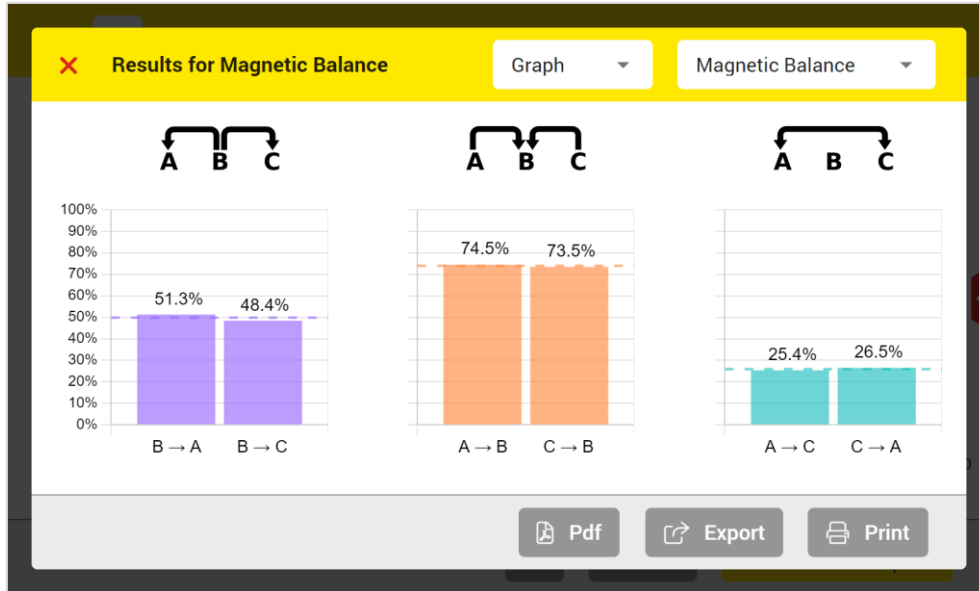

Figure 71: Magnetic balance graph results view

Figure 72 shows also the table results including the colored bar.

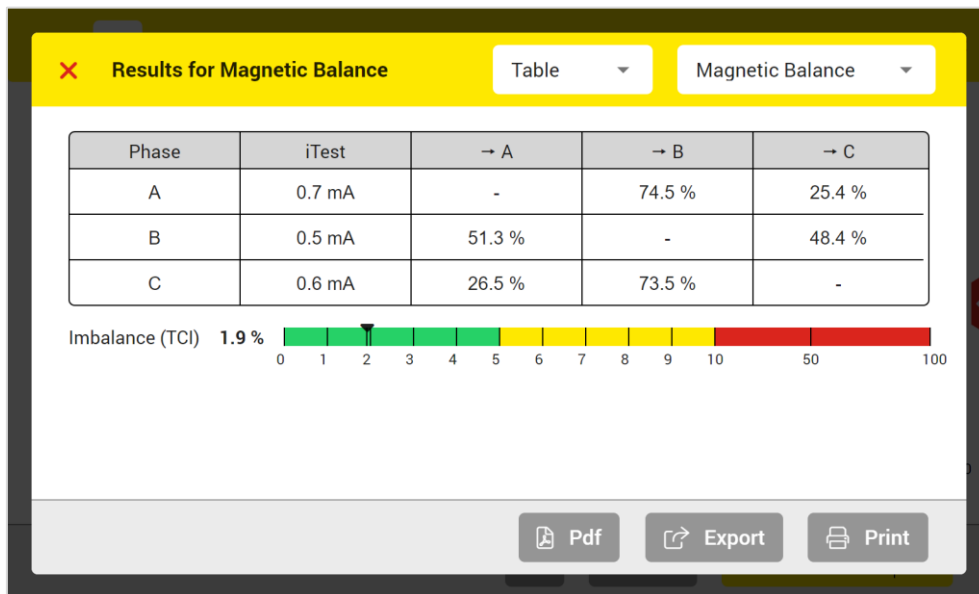

Figure 72: Magnetic balance table results view

10.6 Short Circuit Impedance

The short circuit impedance measurement view explained following the Figure 73.

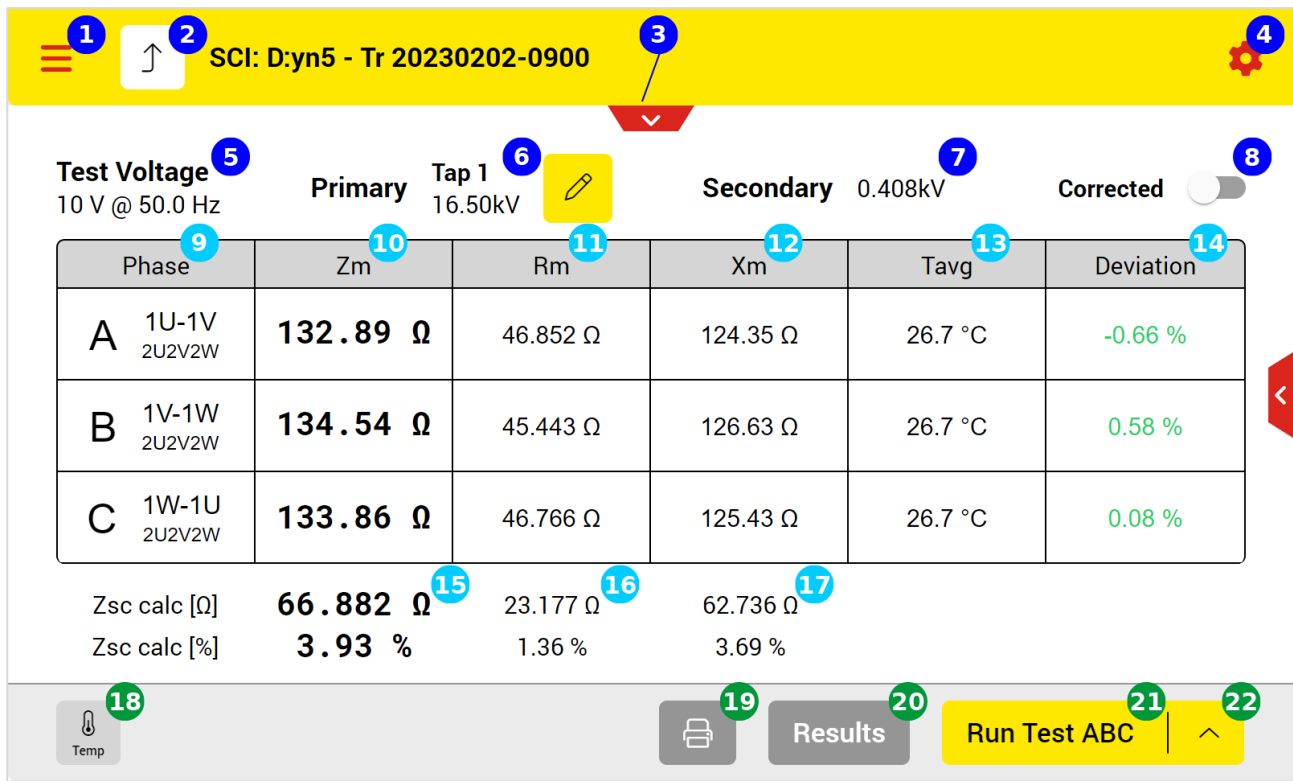

Figure 73: Short circuit impedance measurement view

- 1 Open the main menu
- 2 Back to the test plan page
- 3 Open test object quick access
- 4 Test settings
- 5 The selected test voltage and frequency
- 6 The actual tap position and its rated voltage of primary side. It can be changed by tapping on the pencil button
- 7 The actual tap position and its rated voltage of non-primary side
- 8 To enable or disable the temperature corrected resistance view
- 9 The phase and the corresponding connections which be used automatically by the instrument to test each phase
- 10 The measured short circuit impedance value
- 11 The measured AC resistance value
- 12 The measured Leakage reactance value
- 13 The measured temperature during the measurement or the reference temperature when resistance is corrected
- 14 The deviation from 3 phases short circuit impedance average; green means the deviation is less than the limit and the test is Passed. See chapter 4.5.4

- 15 The short circuit impedance average in Ω and %. For more information see 4.5.1
- 16 The AC resistance average in Ω and %. For more information see 4.5.1
- 17 The leakage reactance average in Ω and %. For more information see 4.5.1
- 18 To see the actual measurement value of each temperature measurement channel
- 19 Print the results by using the thermal printer
- 20 Open the detailed results
- 21 Start test button

Figure 74 shows the short circuit impedance test during the measurement.

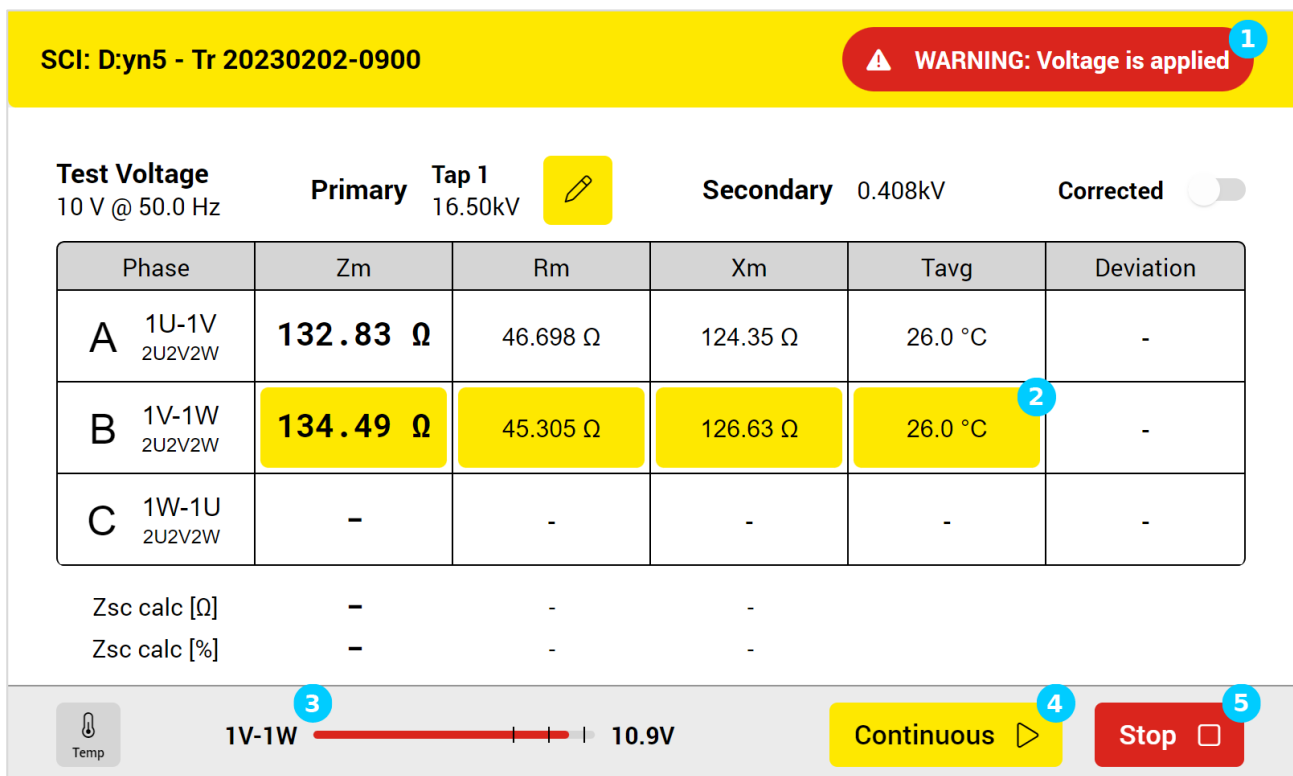

Figure 74: Short circuit impedance test during the measurement

- 1 The warning symbol shows that it is not safe to touch the cables and test clamps
- 2 The highlighted row shows which phase is currently under the test
- 3 The actual test voltage during the measurement
- 4 By tapping the continuous button, the test mode changes from single-measurement to continuous mode and the test will not stop automatically. The instrument keeps performing the test on the phase under the test until the user action
- 5 The stop button can be used to stop the test

10.6.1 Short Circuit Impedance Settings

The short circuit impedance main settings are as follows:

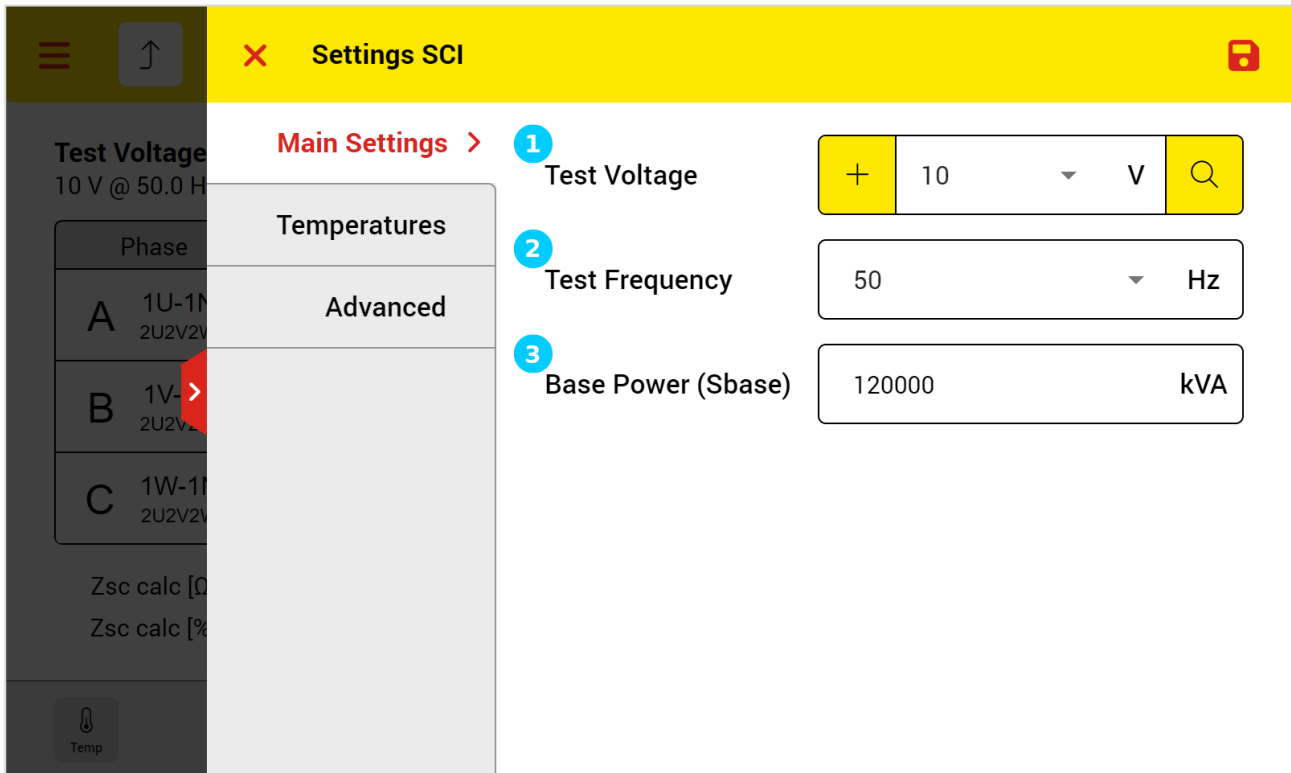

Figure 75: Short circuit impedance main settings

- 1 To select the test voltage. You can also add user defined test voltages to the list by tapping on the + button
- 2 To select the test voltage frequency. The test frequency can be 50Hz or 60Hz. You should select the test frequency according to the working frequency of the test object
- 3 Enter the Base Power or the maximum rated power of the transformer. With the Base Power and the profile rated voltages, the impedance value will be shown also as percent value

Figure 76 shows the short circuit impedance temperature settings. In temperature settings, it is possible to enable each of the 5 temperature channels to record. When there is an external temperature probe, the External switch should be enabled. The reading value must be also entered manually.

The mini-ATOS use the average of all temperature values for the temperature correction.

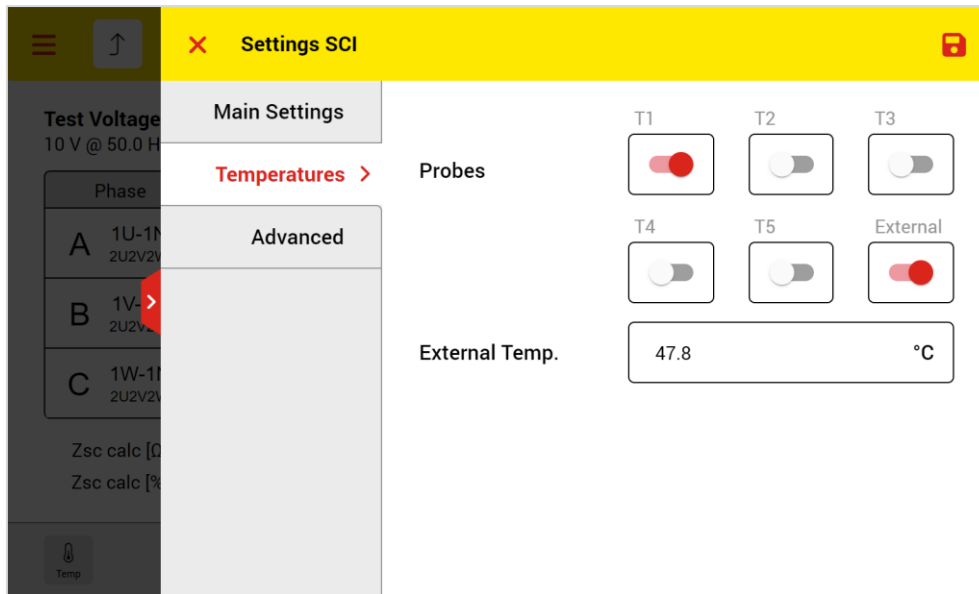

Figure 76: Short circuit impedance temperature settings

Figure 77 shows the short circuit impedance advanced settings.

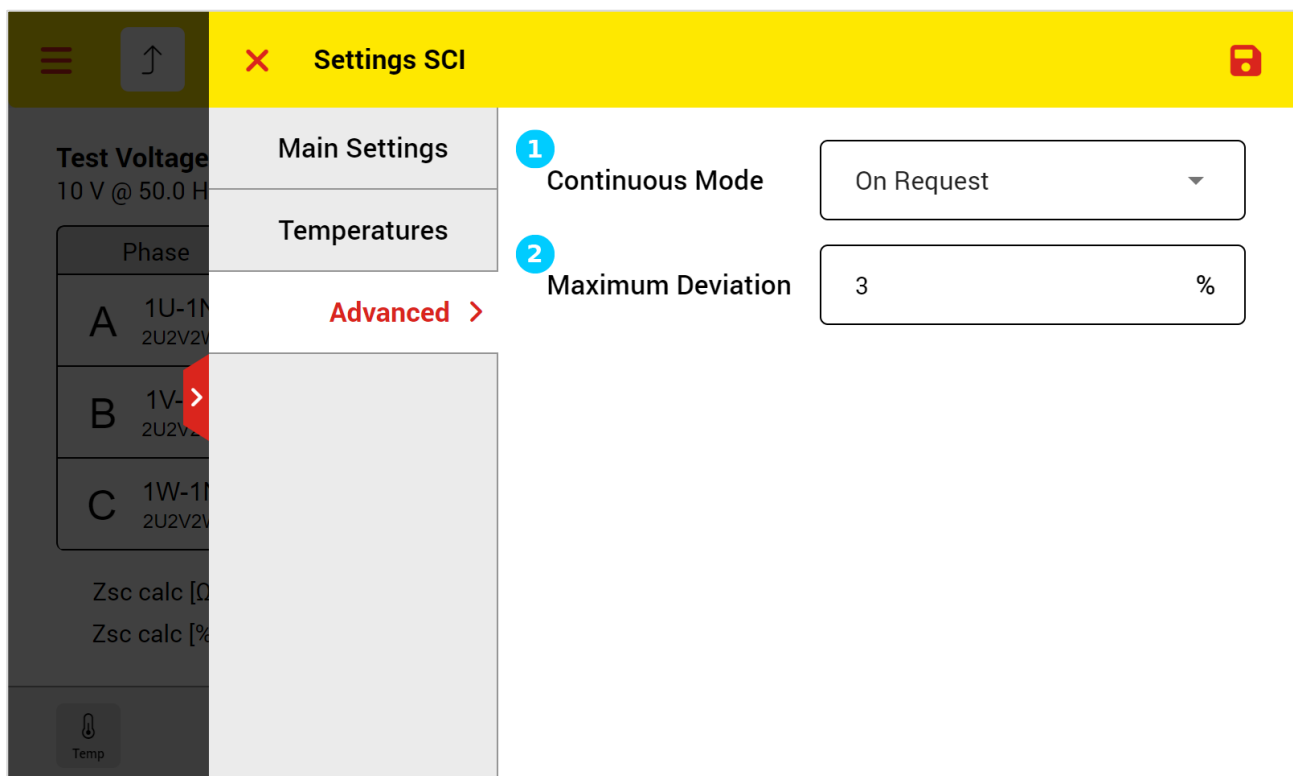

Figure 77: Short circuit impedance advanced settings

- 1 When continuous mode is “On Request”, one can activate the continuous mode only by tapping on the continuous button. When mode is “Always”, the continuous mode is always activated automatically
- 2 The maximum acceptable deviation value. Please see chapter 4.5.4 for more information

11 Go Taps

With go taps, it is possible to perform winding resistance or turns ratio of taps and phases in a sequence of measurements. This helps to measure faster and easier.

To use this option, in the measuring screen and beside the run button, select Run Test Taps from the list of test modes. When you run the test, the Go Taps menu will be first opened as Figure 78. After adjusting the desired parameters, you can start the measurement by using the play icon on the top right of the window.

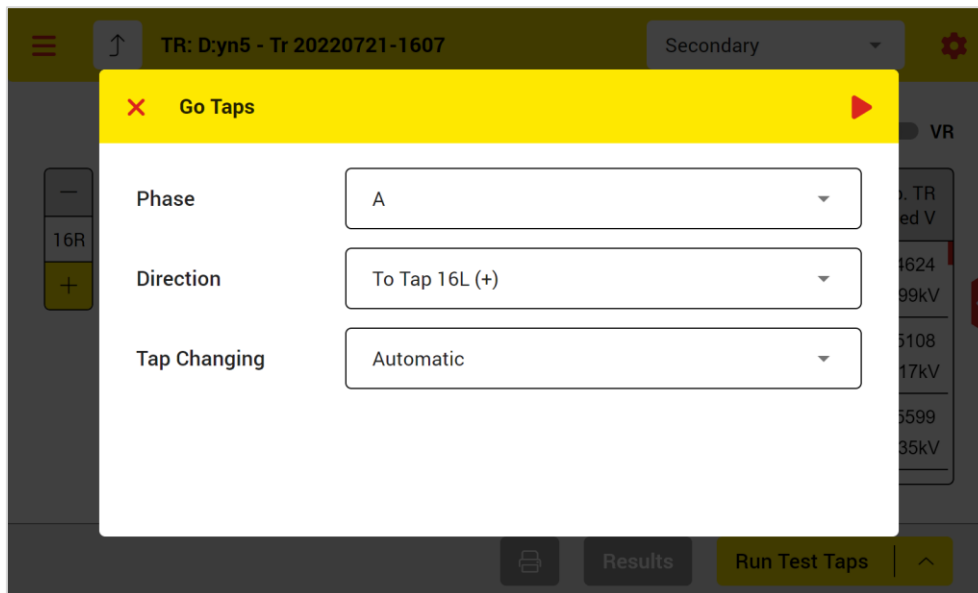

Figure 78: Go Taps menu for turns ratio

Phase

Here, you can select which phase to test. It is possible to test only one phase (e.g. A, B or C), or to test all three phases (ABC) at each tap position. For winding resistance measurement, there is ABC,CBA,ABC,... item which is the optimized three phase version which save time in charge and discharge.

Direction

The tap changing direction should be selected here. You can select either the direction to the first tap or to the last tap.

Tap Changing: Automatic

For automatic tap changing, the mini-ATOS tap control output must be connected to the tap changer control unit for both directions. In the transformer profile, Tap Changer tab also, the tap control must be activated.

During the automatic tap changing, the tap switch window will be shown like Figure 79. In the automatic tap switch window, there is a countdown timer. The system actually waits, so the tap changer has time to change the tap position to the next tap. The waiting period is according to the maximum transition time which was set in the test object profile (Please see chapter 8.1.5). After the waiting period, system performs the next measurement.

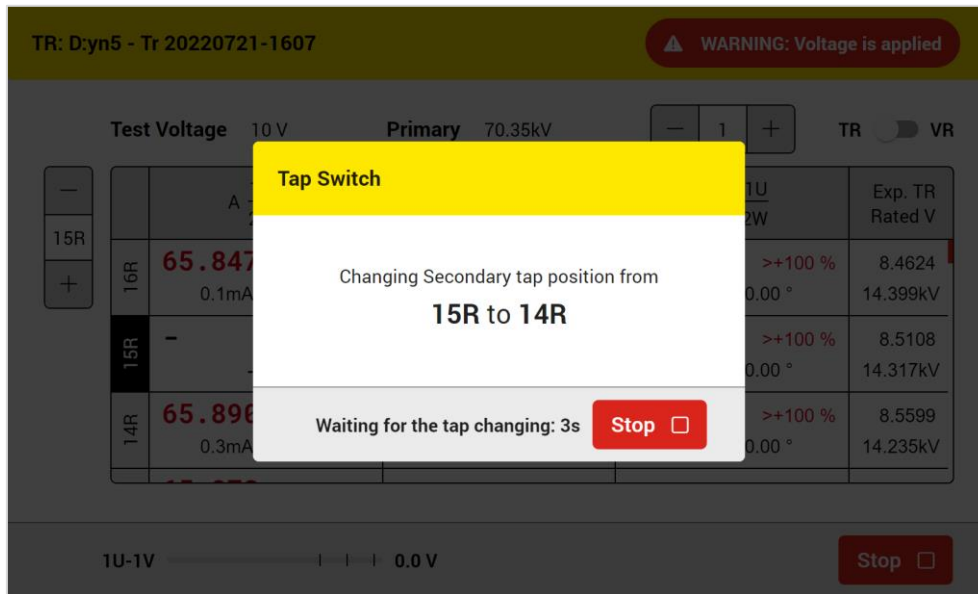

Figure 79: Tap Switch window during automatic tap changing

Tap Changing: Manual

Tap changing can be also manual. During the tap changing, the tap switch window (Figure 80) will ask to change the tap position manually and confirm when it is changed. To confirm, it is possible to tap the confirm button on the screen, and it is also possible to use a hand switch which must be connected to the mini-ATOS External terminal.

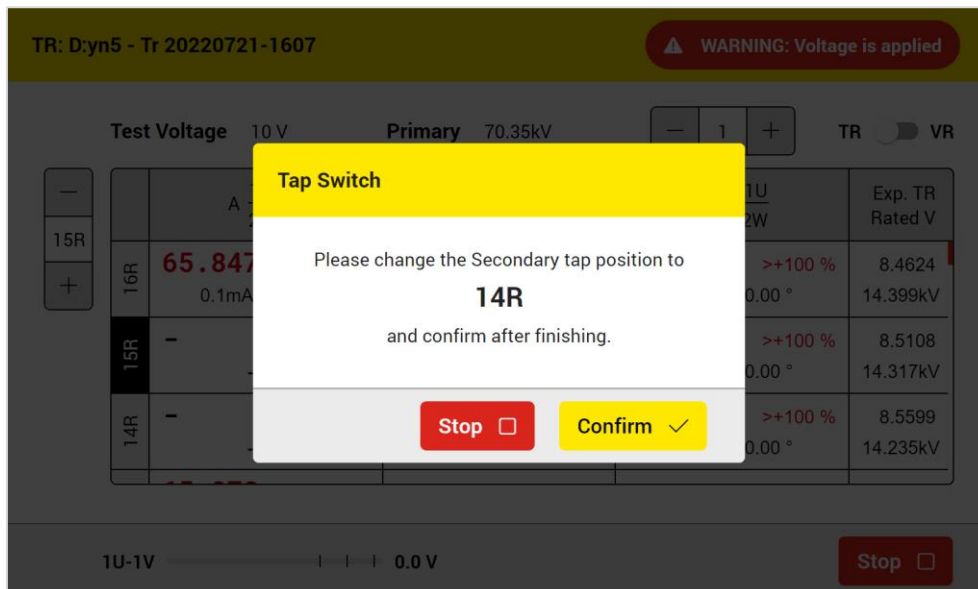



Figure 80: Tap Switch window during manual tap changing

12 Remote Access Instruction

With the remote connection, it is possible to access the device software from other devices such as PC and tablets. The remote connection is possible with the USB or the network connection. When the device is connected, the mini-ATOS can be accessed by using any web browser. For optimal operation, we recommend using Google Chrome or Microsoft Edge browser.

The procedure to use remote access is explained as follows:

- 1- Make sure that Remote access in device settings is enabled (See chapter 7.4.5) and also note what is the access code if it was manually adjusted
- 2- Connect the mini-ATOS to the PC:
 - By using the USB-B cable
 - Or by using the network cable. Make sure that the networking settings are adjusted correctly (Please see chapter 7.4.4)
- 3- From the home page or the main menu, tap the logout icon  to see the select profile page like Figure 81
- 4- Activate remote access on the select profile page. If you didn't input the access key manually in the settings, you will see then the auto-generated access key (Figure 82)
- 5- Open the browser in pc or tablet and then:
 - If the connection is with the USB cable, enter **192.168.11.1** in the address bar to open the software
 - If the connection is with the Network cable, enter the **hostname** (you can find the hostname in the networking settings, please see chapter 7.4.4) after the **http://** (e.g., **http://mini-ATOS-411-101**) in the address bar to open the software
- 6- Enter the access key and confirm to access the software (Figure 83)

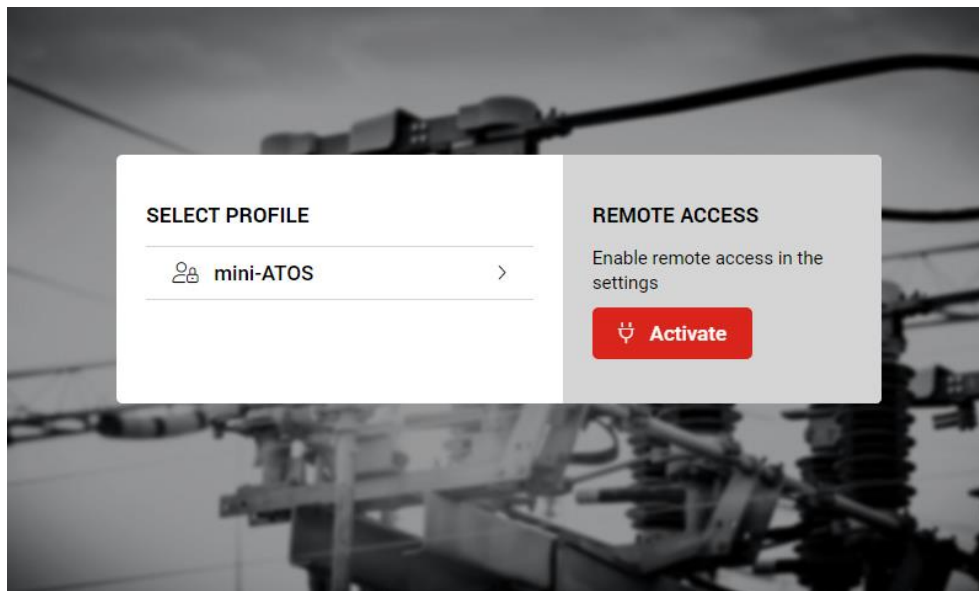

Figure 81: Select Profile page on the mini-ATOS display

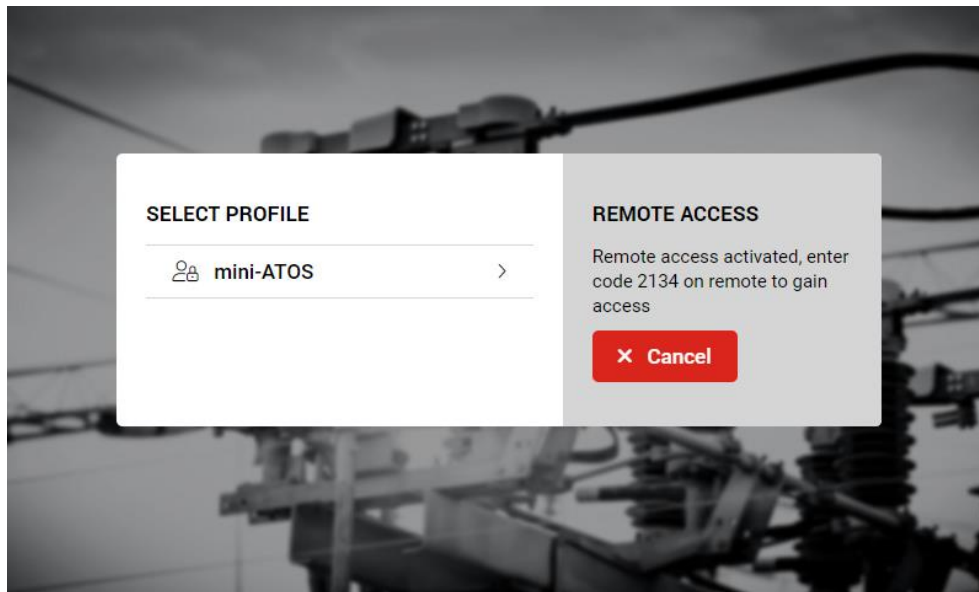

Figure 82: Remote access activated with an auto-generated key on the mini-ATOS display

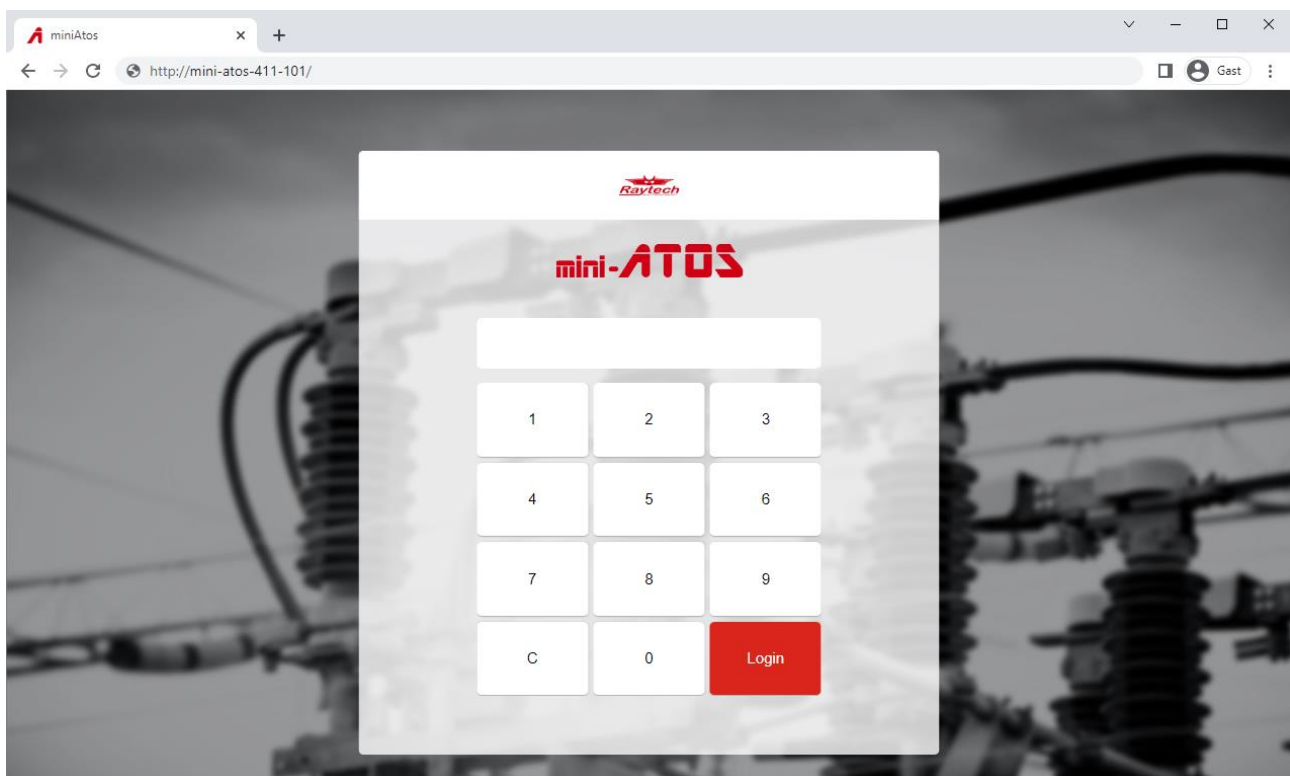

Figure 83: Remote access login page

Notes

- You can always cancel the remote connection from the device
- Only one active session is possible at once
- If the access code is auto-generated, by entering a wrong access code each time, a new code will be generated.

13 Interfaces

13.1 USB

The USB interface consists of two Master connectors and one Slave connector.

The Master connector can be used to update the device and store/load measurement data from USB memory sticks.

It is also possible to connect a USB mouse and a USB keyboard for easier input.

The Slave connector can be used to connect the mini-ATOS to a PC or to connect a USB printer.

USB-Master (Type A) x2

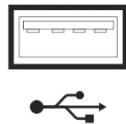

USB-Slave (Type B)

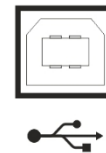

13.2 Ethernet

The Ethernet port can be used to connect the mini-ATOS to a network to enable the remote connection.

RJ45

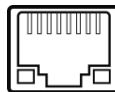

13.3 External (4pins version)

This port is multi-functional and consists of the following functions:

Hand switch for tap changing



Raytech warning lamp



When both hand switch and warning lamp is required then a splitter cable is necessary as follows which can be ordered as an optional item:

Cable adapter hand switch & warning lamp
(4pin to 2x 4pin)



13.4 External (6pins version)

The 6pins external port consists two additional pins to connect an external safety interlock. The function of other 4pins is the same as the 4pins version. The external safety interlock can be for example a safety door or a safety hand switch. The safety interlock must be connected to pin number 5 and 6.

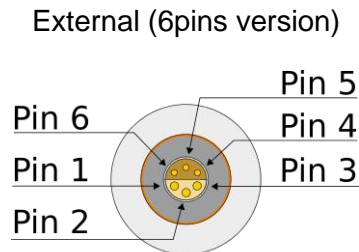

When these pins are shorted, it means that it is safe to perform a measurement. If they are not shorted, it is not possible to start a measurement.

If the connection open during a measurement, measurement will be stopped automatically.

When external safety interlock and either hand switch or warning lamp is required then a splitter cable is necessary as follows which can be ordered as an optional item:

Cable adapter external
(6pin to 6pin & 4pin)



When external safety interlock and both hand switch and warning lamp is required then two splitter cables are necessary as follows which can be ordered as an optional item:

Cable adapter external
(6pin to 6pin & 4pin)

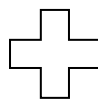

Cable adapter hand switch/ warning lamp
(4pin to 2x 4pin)



13.5 Tap Control

This port is used for an external connection to a tap changer dry contact. With this connection, changing the tap position can be done from the mini-ATOS.



Two connectors are for changing the tap position in up direction and the other two are for changing the tap position in down direction. The cables are marked with labels. The maximum input voltage is 240VAC, Cat II.

14 Technical Specifications

14.1 General

Area of use	Portable to use indoor and outdoor including heavy industrial electromagnetic environments
Enclosure	Industrial high-impact plastic case
Supply	IEC 60320, C13/C14 mains connector, CAT II
Rated input voltages	110/240 VAC @ 50/60Hz, automatic ranging
Absolute input voltages	90-264 VAC @ 47-63Hz
Consumption power	Max. 900VA
Mains protection	2x 5mm x 20mm T10A Fuse
Output power	Max. 600W
Test voltage user selectable (AC)	10,40,100,250 VAC
Max. test current (AC)	1A
Test current user selectable (DC)	0.050-30A and 0.025-7.5A simultaneously
Max. test voltage (DC)	50VDC (100VDC with automatic booster)
Temperature measurement range	-20°C (-4°F) to 110°C (230°F)
Display	7" TFT Color LCD
Input devices	Capacitive touch screen, support mouse and keyboard
Front panel	Sealed, anodized
Interfaces	3 USB 2.0 full speed (2 hosts, 1 device) and Ethernet
Printer	Internal 1.9" thermal printer
Operating temperature	-10°C (14°F) to 55° C (131°F)
Storage temperature	-20°C (-4°F) to 70°C (158°F)
Humidity	5%-95% relative humidity, no condensation
Pollution degree	2
Altitude	Up to 2000m (without derating)
Degree of protection (closed door)	IP67, dust-tight and water immersion up to a 1-meter depth
Degree of protection (open door)	IP20
Size	L: 525 mm (20.7") W: 437 mm (17.2") H: 213 mm (8.4")
Weight (instrument)	16.5 kg (36.4 lbs.)
Weight (accessories)	Please contact
Shipping weight and package size	Please contact

14.2 Accuracies

All accuracies values are measured at an ambient temperature of $23\pm 5^{\circ}\text{C}$ after a warm-up of 30min.

14.2.1 Turns Ratio Measurement

Table 9: Turns ratio accuracy

Parameter	Range	Accuracy	Resolution
Turns Ratio 250VAC @ 55Hz	0.8 ... 200	$\pm 0.04\%$ Rdg ± 1 LSD	5 Digits
	200 ... 5000	$\pm 0.10\%$ Rdg ± 1 LSD	5 Digits
	5000 ... 50000	$\pm 0.40\%$ Rdg ± 1 LSD	5 Digits
Turns Ratio 100VAC @ 55Hz	0.8 ... 200	$\pm 0.04\%$ Rdg ± 1 LSD	5 Digits
	200 ... 2000	$\pm 0.10\%$ Rdg ± 1 LSD	5 Digits
	2000 ... 20000	$\pm 0.40\%$ Rdg ± 1 LSD	5 Digits
Turns Ratio 40VAC @ 55Hz	0.8 ... 200	$\pm 0.04\%$ Rdg ± 1 LSD	5 Digits
	200 ... 2000	$\pm 0.06\%$ Rdg ± 1 LSD	5 Digits
	2000 ... 20000	$\pm 0.40\%$ Rdg ± 1 LSD	5 Digits
Turns Ratio 10VAC @ 55Hz	0.8 ... 200	$\pm 0.06\%$ Rdg ± 1 LSD	5 Digits
	200 ... 5000	$\pm 0.10\%$ Rdg ± 1 LSD	5 Digits

Table 10: Other AC parameters accuracy

Parameter	Range	Accuracy	Resolution
AC Test Current @ 55Hz	0 ... 1 A	$\pm 1.00\%$ Rdg ± 0.01 A	4 Digits
Phase Angle @ 55Hz	$\pm 90^{\circ}$	$\pm 0.05^{\circ}$ Rdg ± 1 LSD	4 Digits or 0.01°
Output Voltage	0 – 250VAC	$\pm 1\%$ ± 1 LSD	4 Digits or 0.1VAC

14.2.2 Resistance Measurements

Table 11: DC resistance accuracies with 50V/7.5A DC power supply

I_{test}	Range	Accuracy	Resolution
5.0 - 7.5A	0.00 $\mu\Omega$... 10 Ω	$\pm 0.10\%$ Rdg $\pm 1.6\mu\Omega$	5 Digits or 0.01 $\mu\Omega$
1.0 – 5.0A	0.00 $\mu\Omega$... 50 Ω	$\pm 0.10\%$ Rdg $\pm 8.0\mu\Omega$	5 Digits
0.5 – 1.0A	0.00 $\mu\Omega$... 100 Ω	$\pm 0.10\%$ Rdg $\pm 16\mu\Omega$	5 Digits
0.1 - 0.5A	0.00 $\mu\Omega$... 500 Ω	$\pm 0.10\%$ Rdg $\pm 80\mu\Omega$	5 Digits
25 - 100mA	0.00 $\mu\Omega$... 2k Ω	$\pm 0.10\%$ Rdg $\pm 320m\Omega$	5 Digits
< 25mA	2k Ω ... 10k Ω	$\pm 0.10\%$ Rdg $\pm 50\Omega$	5 Digits
< 25mA	10k Ω ... 100k Ω	$\pm 1\%$ Rdg $\pm 500\Omega$	5 Digits

Table 12: DC resistance accuracies with 12V/30A DC power supply



I_{test}	Range	Accuracy	Resolution
25.0 – 30.0A	0.00 $\mu\Omega$... 0.48 Ω	$\pm 0.10\%$ Rdg $\pm 0.4\mu\Omega$	5 Digits or 0.01 $\mu\Omega$
20.0 – 25.0A	200 $\mu\Omega$... 0.60 Ω	$\pm 0.10\%$ Rdg $\pm 0.1\mu\Omega$	5 Digits
20.0 – 25.0A	0.00 $\mu\Omega$... 200 $\mu\Omega$	$\pm 0.10\%$ Rdg $\pm 0.3\mu\Omega$	5 Digits
15.0 – 20.0A	0.00 $\mu\Omega$... 0.80 Ω	$\pm 0.10\%$ Rdg $\pm 0.6\mu\Omega$	5 Digits
10.0 – 15.0A	0.00 $\mu\Omega$... 1.2 Ω	$\pm 0.10\%$ Rdg $\pm 0.8\mu\Omega$	5 Digits
5.0 – 10.0A	0.00 $\mu\Omega$... 2.4 Ω	$\pm 0.10\%$ Rdg $\pm 1.6\mu\Omega$	5 Digits
1.0 – 5.0A	0.00 $\mu\Omega$... 12 Ω	$\pm 0.10\%$ Rdg $\pm 8.0\mu\Omega$	5 Digits
0.5 – 1.0A	0.00 $\mu\Omega$... 24 Ω	$\pm 0.10\%$ Rdg $\pm 16\mu\Omega$	5 Digits
0.1 - 0.5A	0.00 $\mu\Omega$... 120 Ω	$\pm 0.10\%$ Rdg $\pm 80\mu\Omega$	5 Digits
50 - 100mA	0.00 $\mu\Omega$... 240 Ω	$\pm 0.10\%$ Rdg $\pm 1.2\Omega$	5 Digits
< 50mA	240 Ω ... 1k Ω	$\pm 0.10\%$ Rdg $\pm 5\Omega$	5 Digits
< 50mA	1k Ω ... 10k Ω	$\pm 1\%$ Rdg $\pm 50\Omega$	5 Digits

14.2.3 Temperature Measurement

Table 13: Output voltage accuracy

Range	Accuracy	Resolution
0 – 70°C	$\pm 0.2^\circ\text{C} \pm 1 \text{ LSD}$	0.1°C

14.3 Standards and Approvals

 	Safety			IEC 61010-1
	EMC	Emission Class A	RF emission	CISPR 11
			Current harmonic emission	IEC 61000-3-2
			Flicker and voltage fluctuations	IEC 61000-3-3
		Immunity industrial electromagnetic environment	Electrostatic discharge (ESD)	IEC 61000-4-2
			Electromagnetic field	IEC 61000-4-3
			Burst	IEC 61000-4-4
			Surge	IEC 61000-4-5
			Conducted RF	IEC 61000-4-6
			Power frequency magnetic field	IEC 61000-4-8
Voltage dip	IEC 61000-4-11			



Appendix

mini-ATOS

mini Automatic Transformer
Observation System

Appendix

A	Warranty Conditions.....	102
A.1	Limitation of Warranty	102
A.2	Arbitration.....	103
B	Maintenance.....	104
B.1	Instrument Cleaning Instruction.....	104
B.2	How to Insert Paper into Thermal Printer.....	104
B.3	Thermal Printer Cleaning Instruction	105
C	Index	106
D	Contacts.....	108

A Warranty Conditions

Raytech AG Switzerland shall at their option and expense, repair or replace any part or parts that prove to be defective within the warranty limitation period- irrespective of the operating time of the test equipment provided that the cause of the defect occurred before the time at which the risk was passed.

Warranty claims are subject to a warranty limitation period of 24 months from the date of shipment.

The purchaser is obligated to immediately notify Raytech AG Switzerland in writing of any defects of the supplied test equipment.

Raytech AG Switzerland must always be allowed to rectify a defect within a reasonable amount of time. The purchaser shall grant an adequate amount of time that the test equipment shall be repaired.

Raytech AG Switzerland covers the costs associated with the repair of the defect; especially the costs for the material and work. The cost for sending the faulty test equipment shall be borne by the purchaser. Raytech AG Switzerland shall not be liable for material damage, or financial loss due to the loss of production, loss of data, loss of information, data or interest, regardless of their legal basis.

Warranty claim rights on replacement parts as well as repair of defective parts shall expire after 12 months.

The warranty limitation period shall be extendable according to the price list. The purchaser has the right to extend the warranty period by purchasing additional warranty years.

A.1 Limitation of Warranty

The foregoing warranty shall not apply to defects resulting from:

- Improper and unauthorized modifications or misuse and abuse of the product, negligence, alteration, modification, faulty installation by the customer, customer's agents or employees.
- Attempted or actual dismantling, disassembling, service or repair by any person, firm, or corporation not specifically authorized in writing by Raytech AG Switzerland.
- Defects caused by or due to handling by the carrier, or incurred during shipment, transshipment, or other moves.
- Inadequate maintenance by the customer, the second source supplied software or interfacing, operation outside the environmental limits, or improper site preparation.

Exclusive remedies provided herein are the customer's sole and exclusive remedies.

Raytech Switzerland shall not be liable for any damages resulting from the use of this equipment whether direct, indirect, special, incidental, or consequential damages, or whether based on contract, tort, or any other legal theory.



INFO:

NO OTHER WARRANTY IS EXPRESSED OR IMPLIED.

A.2 Arbitration

All disputes arising out of or in connection with the contract between the purchaser and Raytech AG Switzerland and including those regarding the legal validity of this contract and this arbitration clause shall be settled out of court and shall be referred to arbitration for final decision.

B Maintenance

B.1 Instrument Cleaning Instruction

- Before the cleaning, disconnect the device from the Mains circuit.
- Use only lint-free cloth for the cleaning and when required slightly dampened with water.
- Never spray cleaners directly on the front panel. You can spray cleaners directly on the outer surface of the case only when the door is closed completely.
- Never use cleaning solutions that contain bleach or abrasives.

B.2 How to Insert Paper into Thermal Printer



- Open the paper tray by slightly pulling the lever upwards. The paper tray can now easily be opened.



- On the paper roll, the printable side is the outside of the paper roll.
- Unwind a few cm (inch) of paper from the roll.
- Keep the layers wound tightly when inserting the paper roll into the paper tray. The paper outside shows towards the printer mechanism.



- Close the paper tray by applying strong pressure.
- You can hear it snap shut. Now the paper can be torn off at the tear-off edge without opening the paper tray again nor the paper sliding through the printer mechanism.

B.3 Thermal Printer Cleaning instruction



- Open the paper tray and remove the paper roll.
- Do not touch the print head as it may be damaged by static electricity.
- Loosen dirt particles at paper, sensor and tear bar with a small brush.
- Forcefully blow into the paper tray to remove the coarse dust.
- Soak Q-tip with isopropanol (IPA) and clean the sensor, platen roll and print head rail, as well as further dirt.
- Other strong contaminations may also be removed with a Q-tip soaked with isopropanol (IPA).

C Index

Access code	30
Archive	25
Auto detect voltage.....	52
autodetect.....	37
Cleaning instruction	86
CSV separator.....	28
Date and time.....	28
DC resistance accuracies	80
DC resistance test.....	13
Decimal separator	28
Demagnetization	16
Demagnetization view	65
Dual supply mode	56
Emergency stop.....	23
Export logs.....	31
First/Last method.....	43
Fuse	22
Go taps	72
Home screen	24
H-Side current	57
Humidity.....	78
Inspections	26
Labels wizard.....	45
Language	28
Temperature unit	28
License.....	32
Max error	52
Maximum acceptable deviation.....	57
Nameplate.....	38
Naming scheme.....	29
Networking.....	29
Number of steps.....	67
Operating temperature.....	78
Rated voltages wizard	43
Reference temperature.....	40
RefTap/Step method.....	44
Relative error	12
Remote access instruction	74
Resistance deviation	15
Safety indicators.....	22
Safety precautions	5
Service codes.....	31
Smart pattern predictor	17
Software update.....	31
SPP method	17
Stability condition	57
Standards and approvals.....	81
Start current.....	67

Storage temperature.....	78
Temperature coefficient	40
Temperature correction.....	14
Templates.....	27
Test plan.....	46
Test voltage	52
Thermal printer cleaning.....	87
Turns ratio.....	10
Turns ratio accuracy.....	79
Turns ratio measurement	10
Turns ratio measurement view	49
Unsafe area	7
Voltage ratio.....	10
Winding configuration autodetect.....	37
Winding resistance measurement view	54
X-Side current.....	57

D Contacts

Raytech Switzerland

Raytech AG
Oberbenenstrasse 11
5620 Bremgarten

Phone: +41 56 648 6010
Fax: +41 56 648 6011

Mail: welcome@raytech.ch
Web: www.ravtech.ch

Your local representative

Raytech USA, Inc.
118 S. 2nd Street
Perkasie, PA 18944

Phone: 267 404 2676
Fax: 267 404 2685

Web: www.raytechusa.com